

SUPPLIED BY PRICE

- * TRUNK CONNECTIONS ARE ALL FNPT.
- * COIL CONNECTIONS ARE ALL FSWT.

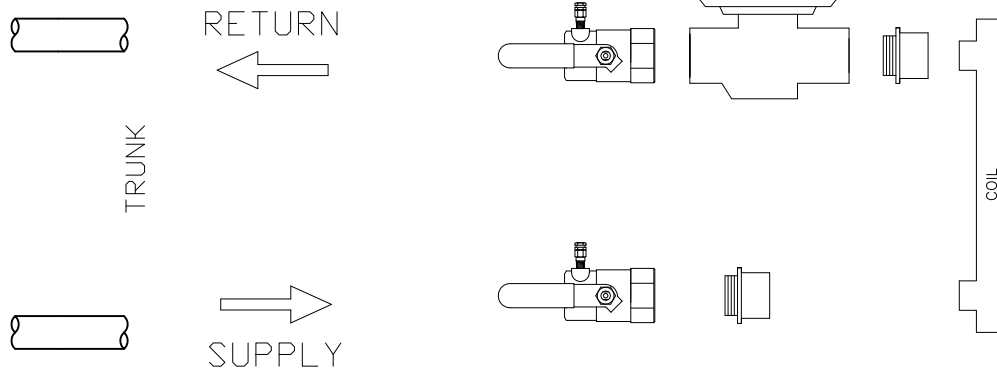

COMPONENTS:

- BALL VALVE WITH PT PORT AND MEMORY STOP
- 2 WAY CONTROL VALVE
- MNPT TO FSWT ADAPTER

- MNPT - MALE NATIONAL PIPE THREAD TAPERED
- FNPT - FEMALE NATIONAL PIPE THREAD TAPERED
- FSWT - FEMALE SWEAT

BASIC 2-WAY PACKAGE

OPTIONS:

WATER COIL

- CHILLED WATER (CW)
- HOT WATER (HW)

COIL CONNECTION

- .625 O.D. = 1/2" NOM
- .875 O.D. = 3/4" NOM
- 1.125 O.D. = 1.0" NOM

STANDARD ATC SIZE

- STD = YES
- NON = NO

VALVE BODY SIZE

- 1/2" (X)
- 3/4" (Y)
- 1" (Z)

ACTUATOR CONTROL

- ON/OFF @ 24 VOLT (024)
- ON/OFF @ 120 VOLT (120)
- ON/OFF @ 208 VOLT (208)
- ON/OFF @ 230 VOLT (230)
- ON/OFF @ 277 VOLT (277)
- FLOATING POINT (FLP)
- MODULATING (MOD)

FLOW RATE (SELECT ONE)

- | | | | | |
|--------------------------------|--------------------------------|--------------------------------|--------------------------------|--------------------------------|
| <input type="checkbox"/> 00.50 | <input type="checkbox"/> 01.63 | <input type="checkbox"/> 03.50 | <input type="checkbox"/> 07.50 | <input type="checkbox"/> 14.00 |
| <input type="checkbox"/> 00.63 | <input type="checkbox"/> 01.75 | <input type="checkbox"/> 04.00 | <input type="checkbox"/> 08.00 | <input type="checkbox"/> 15.00 |
| <input type="checkbox"/> 00.75 | <input type="checkbox"/> 02.00 | <input type="checkbox"/> 04.50 | <input type="checkbox"/> 09.00 | <input type="checkbox"/> 16.00 |
| <input type="checkbox"/> 01.00 | <input type="checkbox"/> 02.25 | <input type="checkbox"/> 05.00 | <input type="checkbox"/> 10.00 | <input type="checkbox"/> 17.00 |
| <input type="checkbox"/> 01.13 | <input type="checkbox"/> 02.50 | <input type="checkbox"/> 05.50 | <input type="checkbox"/> 11.00 | <input type="checkbox"/> 18.00 |
| <input type="checkbox"/> 01.25 | <input type="checkbox"/> 03.00 | <input type="checkbox"/> 06.00 | <input type="checkbox"/> 12.00 | <input type="checkbox"/> 19.00 |
| <input type="checkbox"/> 01.50 | <input type="checkbox"/> 03.25 | <input type="checkbox"/> 07.00 | <input type="checkbox"/> 13.00 | |

MAXIMUM FLOW AND CLOSE OFF PRESSURE (PSI)			
VALVE SIZE	BASIC		MAX GPM FOR NSA
	GPM	PSI	
1/2"	6.00	44	4.00
3/4"	12.00	44	7.00
1"	19.00	22	11.00

VALVE SIZE CV	
VALVE SIZE	BASIC 2 WAY
1/2"	2.5
3/4"	4.1
1"	7.0

STANDARD ATC SIZE	
STDANDARD VALVE SIZE	BASIC FLOW RANGE
1/2"	0.50-6.00
3/4"	6.00-12.00
1"	12.00-19.00

NSA - NOISE SENSITIVE APPLICATIONS

NOTES:

- ON/OFF ACTUATOR CONTROL (24V, 120V, 208V, 230V & 277V) ARE SPRING RETURN EQUIPPED.
- TRUNK CONNECTION WILL MATCH COIL CONNECTION SIZE.
- COIL CONNECTIONS ARE FEMALE SWEAT, TRUNK CONNECTIONS ARE FEMALE NPT.
- 1" PIPING PACKAGES AVAILABLE FOR HIGH PERFORMANCE (FCHCHP, FCHCHPLP) UNITS ONLY.
- IF WATER FLOW EXCEEDS 19 GPM PLEASE CONTACT FACTORY.
- ALL VALVES ARE NORMALLY CLOSED (NC), PLEASE CONTACT FACTORY IF NORMALLY OPEN (NO) IS REQUIRED.
- BASIC PACKAGES SHIPPED AS SEPARATE COMPONENTS FOR FIELD ASSEMBLY AND INSTALLATION BY OTHERS.
- ATC IS SIEMENS STANDARD, HOWEVER OTHER ATCs CAN BE SUPPLIED AS SPECIAL.

ALL METRIC DIMENSIONS () ARE SOFT CONVERTED. IMPERIAL DIMENSIONS ARE CONVERTED TO METRIC AND ROUNDED TO THE NEAREST MILLIMETER.

PROJECT:		PRICE®	
ENGINEER:		BG	BASIC HYDRONIC VALVE PACKAGE 2-WAY FAN COILS
CUSTOMER:		250999	
SUBMITTAL DATE:	SPEC. SYMBOL:	2009/09/14	

SUPPLIED BY PRICE
*BALL VALVE AND CONTROLVALVE CONNECTIONS ARE ALL FNPT

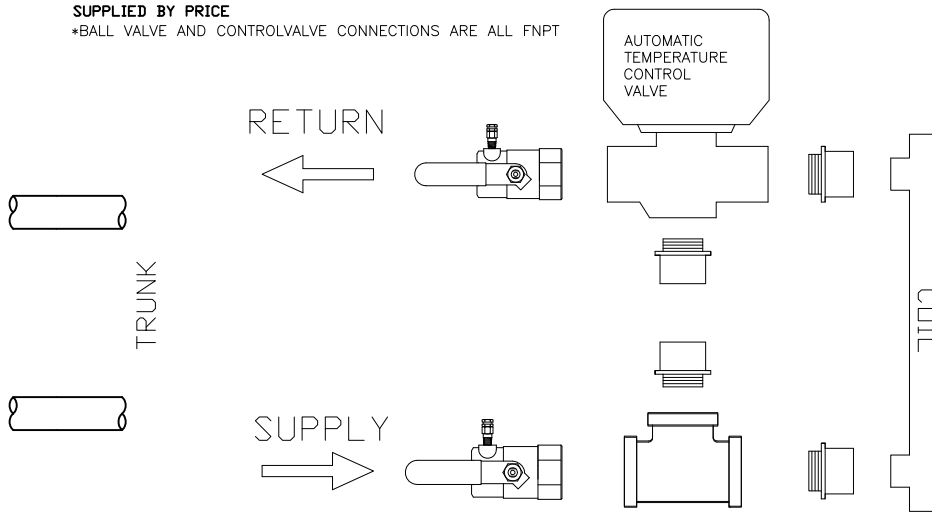

COMPONENTS:

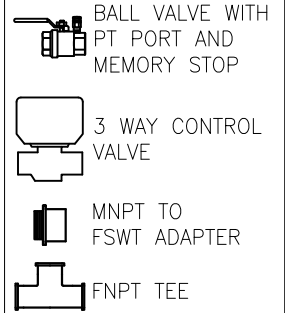

MNPT - MALE NATIONAL PIPE THREAD TAPERED
FNPT - FEMALE NATIONAL PIPE THREAD TAPERED
FSWT - FEMALE SWEAT

BASIC 3-WAY PACKAGE

OPTIONS:

WATER COIL

- CHILLED WATER (CW)
- HOT WATER (HW)

COIL CONNECTION

- .625 O.D. = 1/2" NOM
- .875 O.D. = 3/4" NOM
- 1.125 O.D. = 1.0" NOM

STANDARD ATC SIZE

- STD = YES
- NON = NO

VALVE BODY SIZE

- 1/2" (X)
- 3/4" (Y)
- 1" (Z)

ACTUATOR CONTROL

- ON/OFF @ 24 VOLT (024)
- ON/OFF @ 120 VOLT (120)
- ON/OFF @ 208 VOLT (208)
- ON/OFF @ 230 VOLT (230)
- ON/OFF @ 277 VOLT (277)
- FLOATING POINT (FLP)
- MODULATING (MOD)

FLOW RATE (SELECT ONE)

- | | | | | |
|--------------------------------|--------------------------------|--------------------------------|--------------------------------|--------------------------------|
| <input type="checkbox"/> 00.50 | <input type="checkbox"/> 01.63 | <input type="checkbox"/> 03.50 | <input type="checkbox"/> 07.50 | <input type="checkbox"/> 14.00 |
| <input type="checkbox"/> 00.63 | <input type="checkbox"/> 01.75 | <input type="checkbox"/> 04.00 | <input type="checkbox"/> 08.00 | <input type="checkbox"/> 15.00 |
| <input type="checkbox"/> 00.75 | <input type="checkbox"/> 02.00 | <input type="checkbox"/> 04.50 | <input type="checkbox"/> 09.00 | <input type="checkbox"/> 16.00 |
| <input type="checkbox"/> 01.00 | <input type="checkbox"/> 02.25 | <input type="checkbox"/> 05.00 | <input type="checkbox"/> 10.00 | <input type="checkbox"/> 17.00 |
| <input type="checkbox"/> 01.13 | <input type="checkbox"/> 02.50 | <input type="checkbox"/> 05.50 | <input type="checkbox"/> 11.00 | <input type="checkbox"/> 18.00 |
| <input type="checkbox"/> 01.25 | <input type="checkbox"/> 03.00 | <input type="checkbox"/> 06.00 | <input type="checkbox"/> 12.00 | <input type="checkbox"/> 19.00 |
| <input type="checkbox"/> 01.50 | <input type="checkbox"/> 03.25 | <input type="checkbox"/> 07.00 | <input type="checkbox"/> 13.00 | |

MAXIMUM FLOW AND CLOSE OFF PRESSURE (PSI)			
VALVE SIZE	BASIC		MAX GPM FOR NSA
	GPM	PSI	
1/2"	6.00	44	4.00
3/4"	12.00	44	7.00
1"	19.00	22	11.00

VALVE SIZE CV	
VALVE SIZE	BASIC 3 WAY
1/2"	2.5
3/4"	4.1
1"	7.0

STANDARD ATC SIZE	
STANDARD VALVE SIZE	BASIC FLOW RANGE
1/2"	0.50-6.00
3/4"	6.00-12.00
1"	12.00-19.00

NSA - NOISE SENSITIVE APPLICATIONS

NOTES:

- ON/OFF ACTUATOR CONTROL (24V, 120V, 208V, 230V & 277V) ARE SPRING RETURN EQUIPPED.
- TRUNK CONNECTION WILL MATCH COIL CONNECTION SIZE.
- COIL CONNECTIONS ARE FEMALE SWEAT, TRUNK CONNECTIONS ARE FEMALE NPT.
- 1" PIPING PACKAGES AVAILABLE FOR HIGH PERFORMANCE (FCHCHP, FCHCHPLP) UNITS ONLY.
- IF WATER FLOW EXCEEDS 19 GPM PLEASE CONTACT FACTORY.
- ALL VALVES ARE NORMALLY CLOSED (NC), PLEASE CONTACT FACTORY IF NORMALLY OPEN (NO) IS REQUIRED.
- BASIC PACKAGES SHIPPED AS SEPARATE COMPONENTS FOR FIELD ASSEMBLY AND INSTALLATION BY OTHERS.
- BYPASS AND PIPE EXTENSIONS BY OTHERS.
- ATC IS SIEMENS STANDARD, HOWEVER OTHER ATCS CAN BE SUPPLIED AS SPECIAL.

ALL METRIC DIMENSIONS () ARE SOFT CONVERTED. IMPERIAL DIMENSIONS ARE CONVERTED TO METRIC AND ROUNDED TO THE NEAREST MILLIMETER.

PROJECT:		PRICE®	
ENGINEER:		<i>BG</i>	BASIC HYDRONIC VALVE PACKAGE 3-WAY FAN COILS
CUSTOMER:		251000	
SUBMITTAL DATE:	SPEC. SYMBOL:	2009/09/14	

SUPPLIED BY PRICE

- * TRUNK CONNECTIONS ARE ALL FNPT.
- * COIL CONNECTIONS ARE ALL FSWT.

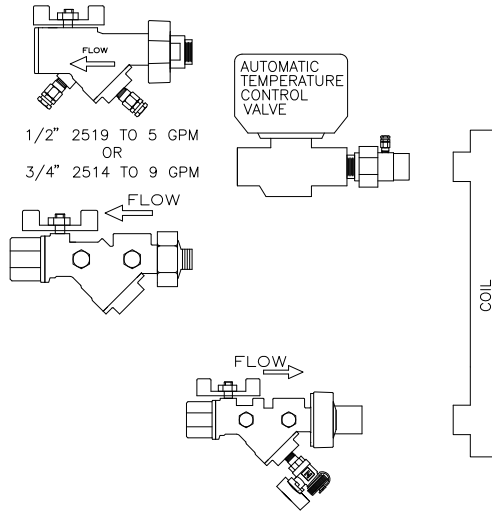
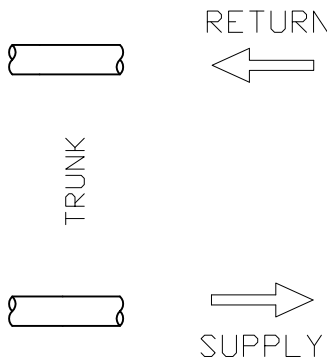

COMPONENTS:

- Y-BALL STRAINER WITH BLOW DOWN VALVE, HOSE CONN. AND P/T PORT
- 2-WAY ATC VALVE
- AUTOMATIC VALVE WITH P/T PORTS
- UNION WITH P/T PORT
- UNION

- MNPT - MALE NATIONAL PIPE THREAD TAPERED
- FNPT - FEMALE NATIONAL PIPE THREAD TAPERED
- FSWT - FEMALE SWEAT
- NSA - NOISE SENSITIVE APPLICATIONS

OPTIONS:

DELUXE 2-WAY PACKAGE W/ AUTOMATIC FLOW CONTROL

WATER COIL

- CHILLED WATER (CW)
- HOT WATER (HW)

COIL CONNECTION

- .625 O.D. = 1/2" NOM
- .875 O.D. = 3/4" NOM
- 1.125 O.D. = 1.0" NOM

ACTUATOR CONTROL

- ON/OFF @ 120 VOLT (120)
- ON/OFF @ 24 VOLT (024)
- ON/OFF @ 208 VOLT (208)
- ON/OFF @ 230 VOLT (230)
- ON/OFF @ 277 VOLT (277)
- FLOATING POINT (FLP)
- MODULATING (MOD)

FLOW RATE (SELECT ONE)

- | | | | | |
|--------------------------------|--------------------------------|--------------------------------|--------------------------------|--------------------------------|
| <input type="checkbox"/> 00.50 | <input type="checkbox"/> 01.63 | <input type="checkbox"/> 03.50 | <input type="checkbox"/> 07.50 | <input type="checkbox"/> 14.00 |
| <input type="checkbox"/> 00.63 | <input type="checkbox"/> 01.75 | <input type="checkbox"/> 04.00 | <input type="checkbox"/> 08.00 | <input type="checkbox"/> 15.00 |
| <input type="checkbox"/> 00.75 | <input type="checkbox"/> 02.00 | <input type="checkbox"/> 04.50 | <input type="checkbox"/> 09.00 | <input type="checkbox"/> 16.00 |
| <input type="checkbox"/> 01.00 | <input type="checkbox"/> 02.25 | <input type="checkbox"/> 05.00 | <input type="checkbox"/> 10.00 | <input type="checkbox"/> 17.00 |
| <input type="checkbox"/> 01.13 | <input type="checkbox"/> 02.50 | <input type="checkbox"/> 05.50 | <input type="checkbox"/> 11.00 | <input type="checkbox"/> 18.00 |
| <input type="checkbox"/> 01.25 | <input type="checkbox"/> 03.00 | <input type="checkbox"/> 06.00 | <input type="checkbox"/> 12.00 | <input type="checkbox"/> 19.00 |
| <input type="checkbox"/> 01.50 | <input type="checkbox"/> 03.25 | <input type="checkbox"/> 07.00 | <input type="checkbox"/> 13.00 | |

STANDARD ATC SIZE

- STD = YES
- NON = NO

VALVE BODY SIZE

- 1/2" (X)
- 3/4" (Y)
- 1" (Z)

MAXIMUM FLOW AND CLOSE OFF PRESSURE (PSI)			
VALVE SIZE	INT./DELUXE		MAX GPM FOR NSA
	GPM	PSI	
1/2"	5.00	44	4.00
3/4"	9.00	44	7.00
1"	19.00	22	11.00

VALVE SIZE CV	
VALVE SIZE	DELUXE 2 WAY
1/2"	2.5
3/4"	4.1
1"	7.0

STANDARD ATC SIZE	
STDANDARD VALVE SIZE	INTERMEDIATE/DELUXE FLOW RANGE
1/2"	0.50-5.00
3/4"	5.00-12.00
1"	12.00-19.00

NOTES:

- ON/OFF ACTUATOR CONTROL (24V, 120V, 208V, 230V, 277V) ARE SPRING RETURN EQUIPPED.
- TRUNK CONNECTION WILL MATCH COIL CONNECTION SIZE.
- COIL CONNECTIONS ARE FEMALE SWEAT, TRUNK CONNECTIONS ARE FEMALE NPT.
- 1" PIPING PACKAGES AND ATC AVAILABLE FOR HIGH PERFORMANCE (FCHCHP, FCHCHPLP) UNITS ONLY.
- IF WATER FLOW EXCEEDS 19 GPM PLEASE CONTACT FACTORY.
- ALL VALVES ARE NORMALLY CLOSED (NC), PLEASE CONTACT FACTORY IF NORMALLY OPEN (NO) IS REQUIRED.
- DELUXE PACKAGES ARE ASSEMBLED AND LEAK TESTED, THEN SHIPPED SEPARATE FOR FINAL FIELD INSTALLATION BY OTHERS.
- AUTOMATIC VALVES WILL MAINTAIN WITHIN ±10% OF THE SELECTED FLOW RATE @ 2-80 PSI PRESSURE DIFFERENTIAL.
- ATC IS SIEMENS STANDARD, HOWEVER OTHER ATCS CAN BE SUPPLIED AS SPECIAL.

ALL METRIC DIMENSIONS () ARE SOFT CONVERTED. IMPERIAL DIMENSIONS ARE CONVERTED TO METRIC AND ROUNDED TO THE NEAREST MILLIMETER.

PROJECT:		PRICE®
ENGINEER:		
CUSTOMER:		DELUXE HYDRONIC
SUBMITTAL DATE:		AUTOMATIC VALVE PACKAGE 2-WAY FAN COILS
SPEC. SYMBOL:		

SUPPLIED BY PRICE

- * TRUNK CONNECTIONS ARE ALL FNPT.
- * COIL CONNECTIONS ARE ALL FSWT.

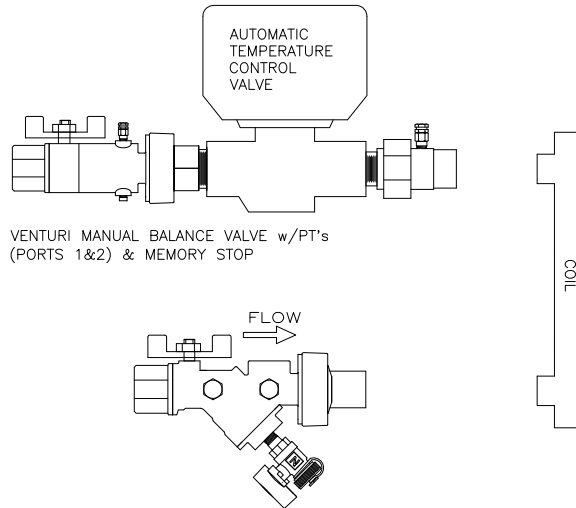
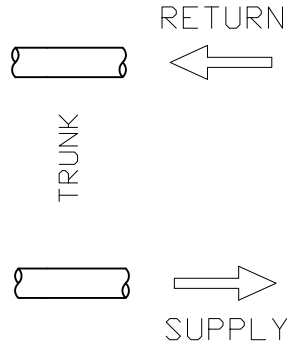

COMPONENTS:

- MANUAL BALANCE VALVE WITH UNION AND P/T
- Y-BALL STRAINER WITH BLOWDOWN VALVE, HOSE CONN. AND P/T PORT
- 2-WAY ATC VALVE
- UNION WITH P/T PORT
- UNION

- MNPT – MALE NATIONAL PIPE THREAD TAPERED
- FNPT – FEMALE NATIONAL PIPE THREAD TAPERED
- FSWT – FEMALE SWEAT

OPTIONS:

DELUXE 2-WAY PACKAGE W/ MANUAL FLOW CONTROL

WATER COIL

- CHILLED WATER (CW)
- HOT WATER (HW)

COIL CONNECTION

- .625 O.D. = 1/2" NOM
- .875 O.D. = 3/4" NOM
- 1.125 O.D. = 1.0" NOM

STANDARD ATC SIZE

- STD = YES
- NON = NO

VALVE BODY SIZE

- 1/2" (X)
- 3/4" (Y)
- 1" (Z)

ACTUATOR CONTROL

- ON/OFF @ 120 VOLT (120)
- ON/OFF @ 24 VOLT (024)
- ON/OFF @ 208 VOLT (208)
- ON/OFF @ 230 VOLT (230)
- ON/OFF @ 277 VOLT (277)
- FLOATING POINT (FLP)
- MODULATING (MOD)

FLOW RATE (SELECT ONE)

- 00.50 01.63 03.50 07.50 14.00
- 00.63 01.75 04.00 08.00 15.00
- 00.75 02.00 04.50 09.00 16.00
- 01.00 02.25 05.00 10.00 17.00
- 01.13 02.50 05.50 11.00 18.00
- 01.25 03.00 06.00 12.00 19.00
- 01.50 03.25 07.00 13.00

MAXIMUM FLOW AND CLOSE OFF PRESSURE (PSI)			
VALVE SIZE	INT./DELUXE		MAX GPM FOR NSA
	GPM	PSI	
1/2"	5.00	44	4.00
3/4"	9.00	44	7.00
1"	19.00	22	11.00

VALVE SIZE CV	
VALVE SIZE	DELUXE 2 WAY
1/2"	2.5
3/4"	4.1
1"	7.0

STANDARD ATC SIZE	
STDANDARD VALVE SIZE	INTERMEDIATE/DELUXE FLOW RANGE
1/2"	0.50–5.00
3/4"	5.00–12.00
1"	12.00–19.00

NOTES:

NSA – NOISE SENSITIVE APPLICATIONS

- ON/OFF ACTUATOR CONTROL (24V, 120V, 208V, 230V, 277V) ARE SPRING RETURN EQUIPPED.
- TRUNK CONNECTION WILL MATCH COIL CONNECTION SIZE.
- COIL CONNECTIONS ARE FEMALE SWEAT, TRUNK CONNECTIONS ARE FEMALE NPT.
- 1" PIPING PACKAGES AND ATC AVAILABLE FOR HIGH PERFORMANCE (FCHCHP, FCHCHPLP) UNITS ONLY.
- IF WATER FLOW EXCEEDS 19 GPM PLEASE CONTACT FACTORY.
- ALL VALVES ARE NORMALLY CLOSED (NC), PLEASE CONTACT FACTORY IF NORMALLY OPEN (NO) IS REQUIRED.
- GPM MUST BE SELECTED ON PACKAGES AS CLOSE TO YOUR DESIGN GPM TO ENSURE PROPER CV ON BALANCING VALVE IS RECEIVED.
- DELUXE PACKAGES ARE ASSEMBLED AND LEAK TESTED, THEN SHIPPED SEPARATE FOR FINAL FIELD INSTALLATION BY OTHERS.
- ATC IS SIEMENS STANDARD, HOWEVER OTHER ATCS CAN BE SUPPLIED AS SPECIAL.

ALL METRIC DIMENSIONS () ARE SOFT CONVERTED. IMPERIAL DIMENSIONS ARE CONVERTED TO METRIC AND ROUNDED TO THE NEAREST MILLIMETER.

PROJECT:		PRICE®	
ENGINEER:			
CUSTOMER:		251002	
SUBMITTAL DATE:	SPEC. SYMBOL:	2009/09/14	

SUPPLIED BY PRICE

- * TRUNK CONNECTIONS ARE ALL FNPT.
- * COIL CONNECTIONS ARE ALL FSWT.

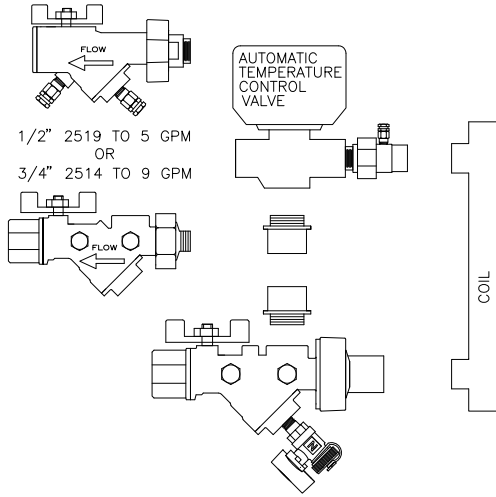
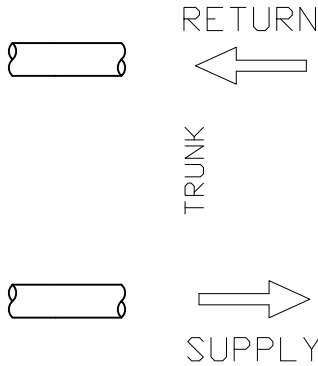

COMPONENTS:

- Y-BALL AUTOMATIC WITH P/T, UNION AND ADAPTER
- Y-BALL STRAINER WITH BLOWDOWN VALVE, HOSE CONN AND P/T PORT
- 3-WAY ATC VALVE
- UNION WITH P/T PORT
- MNPT TO FSWT ADAPTER
- UNION

OPTIONS:

- WATER COIL
 - CHILLED WATER (CW)
 - HOT WATER (HW)
- COIL CONNECTION
 - .625 O.D. = 1/2" NOM
 - .875 O.D. = 3/4" NOM
 - 1.125 O.D. = 1.0" NOM

DELUXE 3-WAY PACKAGE W/ AUTOMATIC FLOW CONTROL

- ACTUATOR CONTROL
- ON/OFF @ 120 VOLT (120)
 - ON/OFF @ 24 VOLT (024)
 - ON/OFF @ 208 VOLT (208)
 - ON/OFF @ 230 VOLT (230)
 - ON/OFF @ 277 VOLT (277)
 - FLOATING POINT (FLP)
 - MODULATING (MOD)

FLOW RATE (SELECT ONE)

- | | | | | |
|--------------------------------|--------------------------------|--------------------------------|--------------------------------|--------------------------------|
| <input type="checkbox"/> 00.50 | <input type="checkbox"/> 01.63 | <input type="checkbox"/> 03.50 | <input type="checkbox"/> 07.50 | <input type="checkbox"/> 14.00 |
| <input type="checkbox"/> 00.63 | <input type="checkbox"/> 01.75 | <input type="checkbox"/> 04.00 | <input type="checkbox"/> 08.00 | <input type="checkbox"/> 15.00 |
| <input type="checkbox"/> 00.75 | <input type="checkbox"/> 02.00 | <input type="checkbox"/> 04.50 | <input type="checkbox"/> 09.00 | <input type="checkbox"/> 16.00 |
| <input type="checkbox"/> 01.00 | <input type="checkbox"/> 02.25 | <input type="checkbox"/> 05.00 | <input type="checkbox"/> 10.00 | <input type="checkbox"/> 17.00 |
| <input type="checkbox"/> 01.13 | <input type="checkbox"/> 02.50 | <input type="checkbox"/> 05.50 | <input type="checkbox"/> 11.00 | <input type="checkbox"/> 18.00 |
| <input type="checkbox"/> 01.25 | <input type="checkbox"/> 03.00 | <input type="checkbox"/> 06.00 | <input type="checkbox"/> 12.00 | <input type="checkbox"/> 19.00 |
| <input type="checkbox"/> 01.50 | <input type="checkbox"/> 03.25 | <input type="checkbox"/> 07.00 | <input type="checkbox"/> 13.00 | |

STANDARD ATC SIZE

- STD = YES
- NON = NO

MAXIMUM FLOW AND CLOSE OFF PRESSURE (PSI)			
VALVE SIZE	INT./DELUXE		MAX GPM FOR NSA
	GPM	PSI	
1/2"	5.00	44	4.00
3/4"	9.00	44	7.00
1"	19.00	22	11.00

NSA - NOISE SENSITIVE APPLICATIONS

VALVE BODY SIZE

- 1/2" (X)
- 3/4" (Y)
- 1" (Z)

VALVE SIZE CV	
VALVE SIZE	DELUXE 3 WAY
1/2"	2.5
3/4"	4.1
1"	7.0

STANDARD ATC SIZE	
STDANDARD VALVE SIZE	INT./DELUXE FLOW RANGE
1/2"	0.50-5.00
3/4"	5.00-12.00
1"	12.00-19.00

NOTES:

- ON/OFF ACTUATOR CONTROL (24V, 120V, 208V, 230V, 277V) ARE SPRING RETURN EQUIPPED.
- TRUNK CONNECTION WILL MATCH COIL CONNECTION SIZE.
- COIL CONNECTIONS ARE FEMALE SWEAT, TRUNK CONNECTIONS ARE FEMALE NPT.
- 1" PIPING PACKAGES AND ATC AVAILABLE FOR HIGH PERFORMANCE (FCHCHP, FCHCHPLP) UNITS ONLY.
- IF WATER FLOW EXCEEDS 19 GPM PLEASE CONTACT FACTORY.
- ALL VALVES ARE NORMALLY CLOSED (NC), PLEASE CONTACT FACTORY IF NORMALLY OPEN (NO) IS REQUIRED.
- DELUXE PACKAGES ARE ASSEMBLED AND TESTED, THEN SHIPPED SEPARATE FOR FINAL FIELD INSTALLATION BY OTHERS.
- BYPASS PIPE EXTENSION BY OTHERS.
- BYPASS ADAPTERS + VALVE SHIPPED LOOSE FOR FIELD INSTALL
- AUTOMATIC VALVES WILL MAINTAIN WITHIN ± 10% OF THE SELECTED FLOW RATE @ 2-80 PSI PRESSURE DIFFERENTIAL.
- ATC IS SIEMENS STANDARD, HOWEVER OTHER ATCs CAN BE SUPPLIED AS SPECIAL.

ALL METRIC DIMENSIONS () ARE SOFT CONVERTED. IMPERIAL DIMENSIONS ARE CONVERTED TO METRIC AND ROUNDED TO THE NEAREST MILLIMETER.

PROJECT:		
ENGINEER:		
CUSTOMER:		
SUBMITTAL DATE:		251003 2009/09/14
SPEC. SYMBOL:		DELUXE HYDRONIC AUTOMATIC VALVE PACKAGE 3-WAY FAN COILS

SUPPLIED BY PRICE

- * TRUNK CONNECTIONS ARE ALL FNPT.
- * COIL CONNECTIONS ARE ALL FSWT.

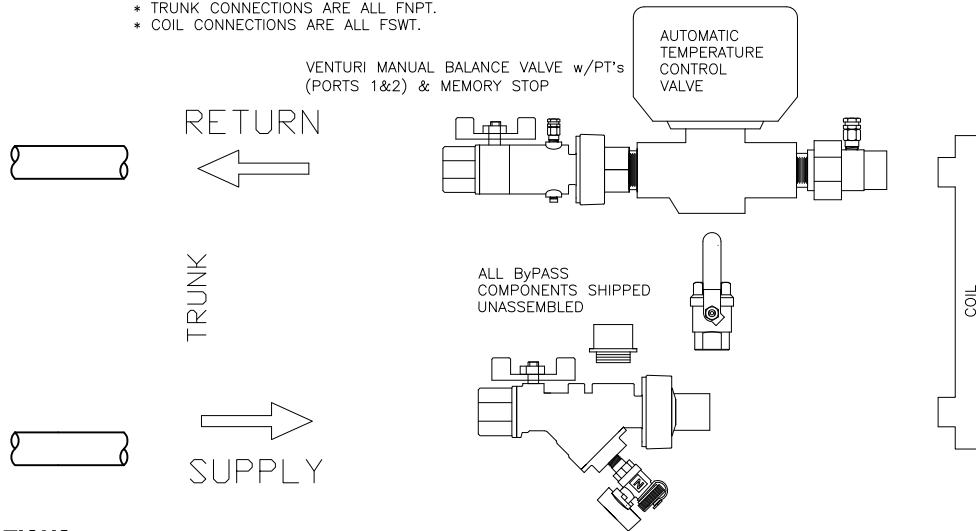

COMPONENTS:

- VENTURI MANUAL VALVE WITH P/T PORTS
- BYPASS BALL VALVE WITH MEMORY STOP
- Y-BALL STRAINER WITH BLOWDOWN VALVE, HOSE CONN. AND ADAPTOR
- 3-WAY ATC VALVE
- UNION WITH P/T PORT
- MNPT TO FSWT ADAPTER
- UNION

OPTIONS:

WATER COIL

- CHILLED WATER (CW)
- HOT WATER (HW)

COIL CONNECTION

- .625 O.D. = 1/2" NOM
- .875 O.D. = 3/4" NOM
- 1.125 O.D. = 1.0" NOM

STANDARD ATC SIZE

- STD = YES
- NON = NO

DELUXE 3-WAY PACKAGE W/ MANUAL FLOW CONTROL

ACTUATOR CONTROL

- ON/OFF @ 120 VOLT (120)
- ON/OFF @ 24 VOLT (024)
- ON/OFF @ 208 VOLT (208)
- ON/OFF @ 230 VOLT (230)
- ON/OFF @ 277 VOLT (277)
- FLOATING POINT (FLP)
- MODULATING (MOD)

FLOW RATE (SELECT ONE)

- | | | | | |
|--------------------------------|--------------------------------|--------------------------------|--------------------------------|--------------------------------|
| <input type="checkbox"/> 00.50 | <input type="checkbox"/> 01.63 | <input type="checkbox"/> 03.50 | <input type="checkbox"/> 07.50 | <input type="checkbox"/> 14.00 |
| <input type="checkbox"/> 00.63 | <input type="checkbox"/> 01.75 | <input type="checkbox"/> 04.00 | <input type="checkbox"/> 08.00 | <input type="checkbox"/> 15.00 |
| <input type="checkbox"/> 00.75 | <input type="checkbox"/> 02.00 | <input type="checkbox"/> 04.50 | <input type="checkbox"/> 09.00 | <input type="checkbox"/> 16.00 |
| <input type="checkbox"/> 01.00 | <input type="checkbox"/> 02.25 | <input type="checkbox"/> 05.00 | <input type="checkbox"/> 10.00 | <input type="checkbox"/> 17.00 |
| <input type="checkbox"/> 01.13 | <input type="checkbox"/> 02.50 | <input type="checkbox"/> 05.50 | <input type="checkbox"/> 11.00 | <input type="checkbox"/> 18.00 |
| <input type="checkbox"/> 01.25 | <input type="checkbox"/> 03.00 | <input type="checkbox"/> 06.00 | <input type="checkbox"/> 12.00 | <input type="checkbox"/> 19.00 |
| <input type="checkbox"/> 01.50 | <input type="checkbox"/> 03.25 | <input type="checkbox"/> 07.00 | <input type="checkbox"/> 13.00 | |

VALVE BODY SIZE

- 1/2" (X)
- 3/4" (Y)
- 1" (Z)

MAXIMUM FLOW AND CLOSE OFF PRESSURE (PSI)					VALVE SIZE CV		STANDARD ATC SIZE	
VALVE SIZE	INT./DELUXE		MAX GPM FOR NSA	VALVE SIZE	DELUXE 3 WAY	STDANDARD VALVE SIZE	INT./DELUXE FLOW RANGE	
	GPM	PSI						
1/2"	5.00	44	4.00	1/2"	2.5	1/2"	0.50-5.00	
3/4"	9.00	44	7.00	3/4"	4.1	3/4"	5.00-12.00	
1"	19.00	22	11.00	1"	7.0	1"	12.00-19.00	

- MNPT - MALE NATIONAL PIPE THREAD TAPERED
- FNPT - FEMALE NATIONAL PIPE THREAD TAPERED
- FSWT - FEMALE SWEAT
- NSA - NOISE SENSITIVE APPLICATIONS

NOTES:

- ON/OFF ACTUATOR CONTROL (24V, 120V, 208V, 230V, 277V) ARE SPRING RETURN EQUIPPED.
- TRUNK CONNECTION WILL MATCH COIL CONNECTION SIZE.
- COIL CONNECTIONS ARE FEMALE SWEAT, TRUNK CONNECTIONS ARE FEMALE NPT.
- 1" PIPING PACKAGES AND ATC AVAILABLE FOR HIGH PERFORMANCE (FCHCHP, FCHCHPLP) UNITS ONLY.
- IF WATER FLOW EXCEEDS 19 GPM PLEASE CONTACT FACTORY.
- ALL VALVES ARE NORMALLY CLOSED (NC), PLEASE CONTACT FACTORY IF NORMALLY OPEN (NO) IS REQUIRED.
- GPM MUST BE SELECTED ON PACKAGES AS CLOSE TO YOUR DESIGN GPM TO ENSURE PROPER CV ON BALANCING VALVE IS RECEIVED.
- DELUXE PACKAGES ARE ASSEMBLED AND TESTED, THEN SHIPPED SEPARATE FOR FINAL FIELD INSTALLATION BY OTHERS.
- BYPASS AND PIPE EXTENSION BY OTHERS.
- BYPASS ADAPTERS + VALVE SHIPPED LOOSE FOR FIELD INSTALL
- ATC IS SIEMENS STANDARD, HOWEVER OTHER ATCs CAN BE SUPPLIED AS SPECIAL.

ALL METRIC DIMENSIONS () ARE SOFT CONVERTED. IMPERIAL DIMENSIONS ARE CONVERTED TO METRIC AND ROUNDED TO THE NEAREST MILLIMETER.

PROJECT:		PRICE®	
ENGINEER:			
CUSTOMER:		251004	
SUBMITTAL DATE:	SPEC. SYMBOL:	2009/09/14	

SUPPLIED BY PRICE

- * TRUNK CONNECTIONS ARE ALL FNPT.
- * COIL CONNECTIONS ARE ALL FSWT.

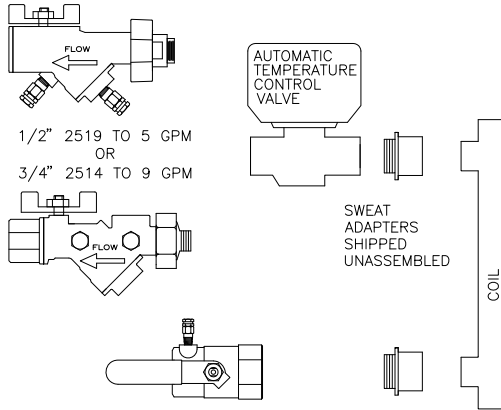
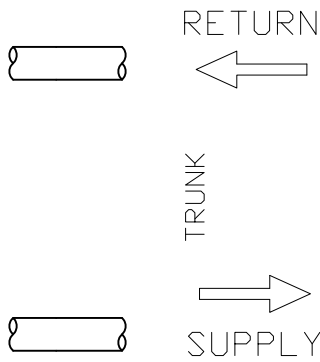

COMPONENTS:

- AUTOMATIC CIRCUIT SETTER
- BYPASS BALL VALVE WITH MEMORY STOP
- 2-WAY ATC VALVE
- MNPT TO FSWT ADAPTER

- MNPT - MALE NATIONAL PIPE THREAD TAPERED
- FNPT - FEMALE NATIONAL PIPE THREAD TAPERED
- FSWT - FEMALE SWEAT

INTERMEDIATE 2-WAY PACKAGE W/ AUTOMATIC FLOW CONTROL

OPTIONS:

- WATER COIL
- CHILLED WATER (CW)
- HOT WATER (HW)
- COIL CONNECTION
- .625 O.D. = 1/2" NOM
- .875 O.D. = 3/4" NOM
- 1.125 O.D. = 1.0" NOM

ACTUATOR CONTROL

- ON/OFF @ 120 VOLT (120)
- ON/OFF @ 24 VOLT (024)
- ON/OFF @ 208 VOLT (208)
- ON/OFF @ 230 VOLT (230)
- ON/OFF @ 277 VOLT (277)
- FLOATING POINT (FLP)
- MODULATING (MOD)

FLOW RATE (SELECT ONE)

- | | | | | |
|--------------------------------|--------------------------------|--------------------------------|--------------------------------|--------------------------------|
| <input type="checkbox"/> 00.50 | <input type="checkbox"/> 01.63 | <input type="checkbox"/> 03.50 | <input type="checkbox"/> 07.50 | <input type="checkbox"/> 14.00 |
| <input type="checkbox"/> 00.63 | <input type="checkbox"/> 01.75 | <input type="checkbox"/> 04.00 | <input type="checkbox"/> 08.00 | <input type="checkbox"/> 15.00 |
| <input type="checkbox"/> 00.75 | <input type="checkbox"/> 02.00 | <input type="checkbox"/> 04.50 | <input type="checkbox"/> 09.00 | <input type="checkbox"/> 16.00 |
| <input type="checkbox"/> 01.00 | <input type="checkbox"/> 02.25 | <input type="checkbox"/> 05.00 | <input type="checkbox"/> 10.00 | <input type="checkbox"/> 17.00 |
| <input type="checkbox"/> 01.13 | <input type="checkbox"/> 02.50 | <input type="checkbox"/> 05.50 | <input type="checkbox"/> 11.00 | <input type="checkbox"/> 18.00 |
| <input type="checkbox"/> 01.25 | <input type="checkbox"/> 03.00 | <input type="checkbox"/> 06.00 | <input type="checkbox"/> 12.00 | <input type="checkbox"/> 19.00 |
| <input type="checkbox"/> 01.50 | <input type="checkbox"/> 03.25 | <input type="checkbox"/> 07.00 | <input type="checkbox"/> 13.00 | |

STANDARD ATC SIZE

- STD = YES
- NON = NO

VALVE BODY SIZE

- 1/2" (X)
- 3/4" (Y)
- 1" (Z)

MAXIMUM FLOW AND CLOSE OFF PRESSURE (PSI)			
VALVE SIZE	INT./DELUXE		MAX GPM FOR NSA
	GPM	PSI	
1/2"	5.00	44	4.00
3/4"	9.00	44	7.00
1"	19.00	22	11.00

NSA - NOISE SENSITIVE APPLICATIONS

VALVE SIZE CV	
VALVE SIZE	INTERMED. 2 WAY
1/2"	2.5
3/4"	4.1
1"	7.0

STANDARD ATC SIZE	
STDANDARD VALVE SIZE	INT./DELUXE FLOW RANGE
1/2"	0.50-5.00
3/4"	5.00-12.00
1"	12.00-19.00

NOTES:

- ON/OFF ACTUATOR CONTROL (24V, 120V, 208V, 230V, 277V) ARE SPRING RETURN EQUIPPED.
- TRUNK CONNECTION WILL MATCH COIL CONNECTION SIZE.
- COIL CONNECTIONS ARE FEMALE SWEAT, TRUNK CONNECTIONS ARE FEMALE NPT.
- 1" PIPING PACKAGES AND ATC AVAILABLE FOR HIGH PERFORMANCE (FCHCHP, FCHCHPLP) UNITS ONLY.
- IF WATER FLOW EXCEEDS 19 GPM PLEASE CONTACT FACTORY.
- ALL VALVES ARE NORMALLY CLOSED (NC), PLEASE CONTACT FACTORY IF NORMALLY OPEN (NO) IS REQUIRED.
- AUTOMATIC VALVES WILL MAINTAIN WITHIN ±10% OF THE SELECTED FLOW RATE @ 2-80 PSI PRESSURE DIFFERENTIAL.
- INTERMEDIATE PACKAGES ARE ASSEMBLED AND LEAK TESTED, THEN SHIPPED SEPARATE FOR FINAL FIELD INSTALLATION BY OTHERS.
- ATC IS SIEMENS STANDARD, HOWEVER OTHER ATCs CAN BE SUPPLIED AS SPECIAL.

ALL METRIC DIMENSIONS () ARE SOFT CONVERTED. IMPERIAL DIMENSIONS ARE CONVERTED TO METRIC AND ROUNDED TO THE NEAREST MILLIMETER.

PROJECT:		PRICE[®]	
ENGINEER:		BG	INTERMEDIATE HYDRONIC AUTOMATIC VALVE PACKAGE, 2-WAY FAN COILS
CUSTOMER:		251005	
SUBMITTAL DATE:	SPEC. SYMBOL:	2009/09/14	

SUPPLIED BY PRICE

- * TRUNK CONNECTIONS ARE ALL FNPT.
- * COIL CONNECTIONS ARE ALL FSWT.

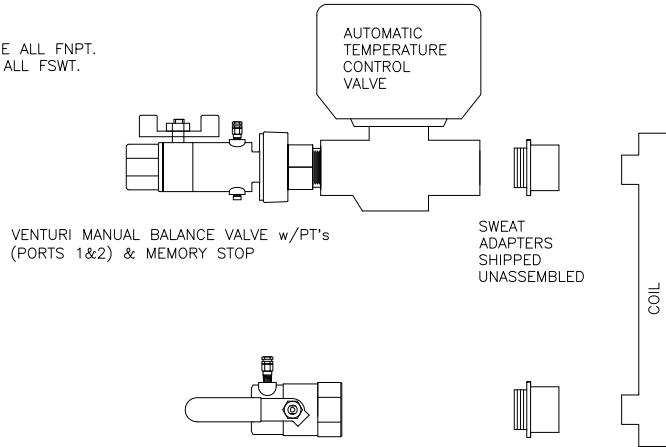
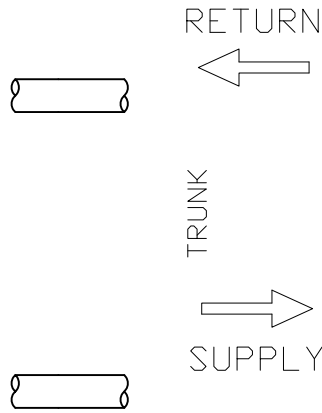

COMPONENTS:

- MANUAL BALANCING VALVE W/ UNION & P/T
- BALL VALVE WITH P/T PORT
- 2-WAY ATC VALVE
- MNPT TO FSWT ADAPTER

- MNPT - MALE NATIONAL PIPE THREAD TAPERED
- FNPT - FEMALE NATIONAL PIPE THREAD TAPERED
- FSWT - FEMALE SWEAT
- NSA - NOISE SENSITIVE APPLICATIONS

OPTIONS:

INTERMEDIATE 2-WAY PACKAGE W/ MANUAL FLOW CONTROL

WATER COIL

- CHILLED WATER (CW)
- HOT WATER (HW)

COIL CONNECTION

- .625 O.D. = 1/2" NOM
- .875 O.D. = 3/4" NOM
- 1.125 O.D. = 1.0" NOM

STANDARD ATC SIZE

- STD = YES
- NON = NO

VALVE BODY SIZE

- 1/2" (X)
- 3/4" (Y)
- 1" (Z)

ACTUATOR CONTROL

- ON/OFF @ 120 VOLT (120)
- ON/OFF @ 24 VOLT (024)
- ON/OFF @ 208 VOLT (208)
- ON/OFF @ 230 VOLT (230)
- ON/OFF @ 277 VOLT (277)
- FLOATING POINT (FLP)
- MODULATING (MOD)

FLOW RATE (SELECT ONE)

- 00.50 01.63 03.50 07.50 14.00
- 00.63 01.75 04.00 08.00 15.00
- 00.75 02.00 04.50 09.00 16.00
- 01.00 02.25 05.00 10.00 17.00
- 01.13 02.50 05.50 11.00 18.00
- 01.25 03.00 06.00 12.00 19.00
- 01.50 03.25 07.00 13.00

MAXIMUM FLOW AND CLOSE OFF PRESSURE (PSI)				
VALVE SIZE	INT./DELUXE		MAX GPM FOR NSA	
	GPM	PSI		
1/2"	5.00	44	4.00	
3/4"	9.00	44	7.00	
1"	19.00	22	11.00	

VALVE SIZE CV	
VALVE SIZE	INTERMED. 2 WAY
1/2"	2.5
3/4"	4.1
1"	7.0

STANDARD ATC SIZE	
STDANDARD VALVE SIZE	INT./DELUXE FLOW RANGE
1/2"	0.50-5.00
3/4"	5.00-12.00
1"	12.00-19.00

NOTES:

- ON/OFF ACTUATOR CONTROL (24V, 120V, 208V, 230V, 277V) ARE SPRING RETURN EQUIPPED.
- TRUNK CONNECTION WILL MATCH COIL CONNECTION SIZE.
- COIL CONNECTIONS ARE FEMALE SWEAT, TRUNK CONNECTIONS ARE FEMALE NPT.
- 1" PIPING PACKAGES AND ATC AVAILABLE FOR HIGH PERFORMANCE (FCHCHP, FCHCHPLP) UNITS ONLY.
- IF WATER FLOW EXCEEDS 19 GPM PLEASE CONTACT FACTORY.
- ALL VALVES ARE NORMALLY CLOSED (NC), PLEASE CONTACT FACTORY IF NORMALLY OPEN (NO) IS REQUIRED.
- GPM MUST BE SELECTED ON PACKAGES AS CLOSE TO YOUR DESIGN GPM TO ENSURE PROPER CV ON BALANCING VALVE IS RECEIVED.
- INTERMEDIATE PACKAGES ARE ASSEMBLED AND LEAK TESTED, THEN SHIPPED SEPARATE FOR FINAL FIELD INSTALLATION BY OTHERS.
- ATC IS SIEMENS STANDARD, HOWEVER OTHER ATCs CAN BE SUPPLIED AS SPECIAL.

ALL METRIC DIMENSIONS () ARE SOFT CONVERTED. IMPERIAL DIMENSIONS ARE CONVERTED TO METRIC AND ROUNDED TO THE NEAREST MILLIMETER.

PROJECT:		PRICE®	
ENGINEER:			
CUSTOMER:		251006	INTERMEDIATE HYDRONIC MANUAL VALVE PACKAGE, 2-WAY FAN COILS
SUBMITTAL DATE:	SPEC. SYMBOL:	2009/09/14	

SUPPLIED BY PRICE

- * TRUNK CONNECTIONS ARE ALL FNPT.
- * COIL CONNECTIONS ARE ALL FSWT.

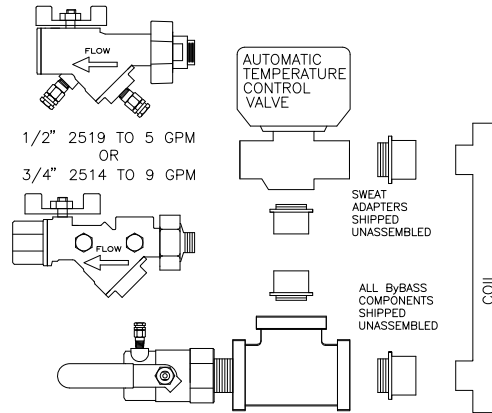
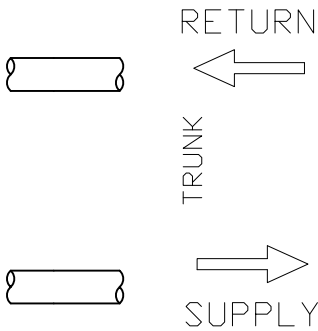

COMPONENTS:

- Y-BALL MEASURFLO WITH P/T, UNION AND ADAPTER
- BALL VALVE WITH PT PORT
- HAYS 3-WAY ATC VALVE
- FNPT TEE
- MNPT TO FSWT ADAPTER

- MNPT - MALE NATIONAL PIPE THREAD TAPERED
- FNPT - FEMALE NATIONAL PIPE THREAD TAPERED
- FSWT - FEMALE SWEAT
- NSA - NOISE SENSITIVE APPLICATIONS

OPTIONS:

INTERMEDIATE 3-WAY PACKAGE W/ AUTOMATIC FLOW CONTROL

WATER COIL

- CHILLED WATER (CW)
- HOT WATER (HW)

COIL CONNECTION

- .625 O.D. = 1/2" NOM
- .875 O.D. = 3/4" NOM
- 1.125 O.D. = 1.0" NOM

STANDARD ATC SIZE

- STD = YES
- NON = NO

VALVE BODY SIZE

- 1/2" (X)
- 3/4" (Y)
- 1" (Z)

ACTUATOR CONTROL

- ON/OFF @ 120 VOLT (120)
- ON/OFF @ 24 VOLT (024)
- ON/OFF @ 208 VOLT (208)
- ON/OFF @ 230 VOLT (230)
- ON/OFF @ 277 VOLT (277)
- FLOATING POINT (FLP)
- MODULATING (MOD)

FLOW RATE (SELECT ONE)

- | | | | | |
|--------------------------------|--------------------------------|--------------------------------|--------------------------------|--------------------------------|
| <input type="checkbox"/> 00.50 | <input type="checkbox"/> 01.63 | <input type="checkbox"/> 03.50 | <input type="checkbox"/> 07.50 | <input type="checkbox"/> 14.00 |
| <input type="checkbox"/> 00.63 | <input type="checkbox"/> 01.75 | <input type="checkbox"/> 04.00 | <input type="checkbox"/> 08.00 | <input type="checkbox"/> 15.00 |
| <input type="checkbox"/> 00.75 | <input type="checkbox"/> 02.00 | <input type="checkbox"/> 04.50 | <input type="checkbox"/> 09.00 | <input type="checkbox"/> 16.00 |
| <input type="checkbox"/> 01.00 | <input type="checkbox"/> 02.25 | <input type="checkbox"/> 05.00 | <input type="checkbox"/> 10.00 | <input type="checkbox"/> 17.00 |
| <input type="checkbox"/> 01.13 | <input type="checkbox"/> 02.50 | <input type="checkbox"/> 05.50 | <input type="checkbox"/> 11.00 | <input type="checkbox"/> 18.00 |
| <input type="checkbox"/> 01.25 | <input type="checkbox"/> 03.00 | <input type="checkbox"/> 06.00 | <input type="checkbox"/> 12.00 | <input type="checkbox"/> 19.00 |
| <input type="checkbox"/> 01.50 | <input type="checkbox"/> 03.25 | <input type="checkbox"/> 07.00 | <input type="checkbox"/> 13.00 | |

MAXIMUM FLOW AND CLOSE OFF PRESSURE (PSI)			
VALVE SIZE	INT./DELUXE		MAX GPM FOR NSA
	GPM	PSI	
1/2"	5.00	44	4.00
3/4"	9.00	44	7.00
1"	19.00	22	11.00

VALVE SIZE CV	
VALVE SIZE	INTERMED. 3 WAY
1/2"	2.5
3/4"	4.1
1"	7.0

STANDARD ATC SIZE	
STDANDARD VALVE SIZE	INT./DELUXE FLOW RANGE
1/2"	0.50-5.00
3/4"	5.00-12.00
1"	12.00-19.00

NOTES:

- ON/OFF ACTUATOR CONTROL (24V, 120V, 208V, 230V, 277V) ARE SPRING RETURN EQUIPPED.
- TRUNK CONNECTION WILL MATCH COIL CONNECTION SIZE.
- COIL CONNECTIONS ARE FEMALE SWEAT, TRUNK CONNECTIONS ARE FEMALE NPT.
- 1" PIPING PACKAGES AND ATC AVAILABLE FOR HIGH PERFORMANCE (FCHCHP, FCHCHPLP) UNITS ONLY.
- IF WATER FLOW EXCEEDS 19 GPM PLEASE CONTACT FACTORY.
- ALL VALVES ARE NORMALLY CLOSED (NC), PLEASE CONTACT FACTORY IF NORMALLY OPEN (NO) IS REQUIRED.
- AUTOMATIC VALVES WILL MAINTAIN WITHIN ±10% OF THE SELECTED FLOW RATE @ 2-80 PSI PRESSURE DIFFERENTIAL.
- INTERMEDIATE PACKAGES ARE ASSEMBLED AND LEAK TESTED, THEN SHIPPED SEPARATE FOR FINAL FIELD INSTALLATION BY OTHERS.
- BYPASS AND PIPE EXTENSION BY OTHERS.
- ATC IS SIEMENS STANDARD, HOWEVER OTHER ATCS CAN BE SUPPLIED AS SPECIAL.

ALL METRIC DIMENSIONS () ARE SOFT CONVERTED. IMPERIAL DIMENSIONS ARE CONVERTED TO METRIC AND ROUNDED TO THE NEAREST MILLIMETER.

PROJECT:		PRICE®	
ENGINEER:			
CUSTOMER:		251007	INTERMEDIATE HYDRONIC AUTOMATIC VALVE PACKAGE, 3-WAY FAN COILS
SUBMITTAL DATE:	SPEC. SYMBOL:	2009/09/14	

SUPPLIED BY PRICE

- * TRUNK CONNECTIONS ARE ALL FNPT.
- * COIL CONNECTIONS ARE ALL FSWT.

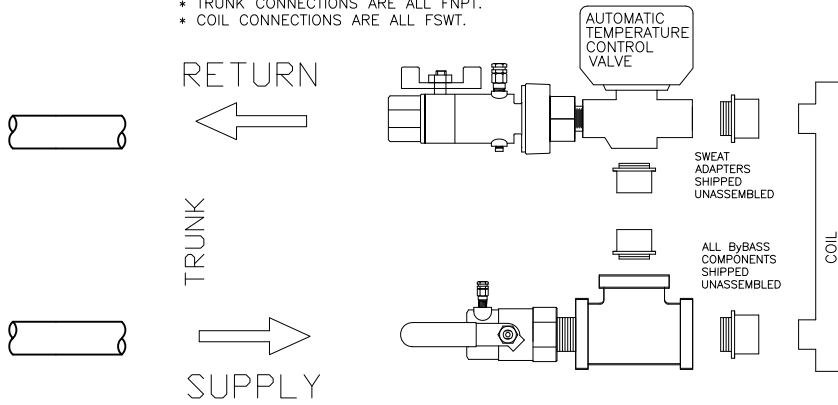

COMPONENTS:

- VENTURI MANUAL BALANCING VALVE W/ UNION & P/T
- BALL VALVE WITH PT PORT
- 3-WAY ATC VALVE
- FNPT TEE
- MNPT TO FSWT ADAPTER

MNPT – MALE NATIONAL PIPE THREAD TAPERED
 FNPT – FEMALE NATIONAL PIPE THREAD TAPERED
 FSWT – FEMALE SWEAT
 NSA – NOISE SENSITIVE APPLICATIONS

INTERMEDIATE 3-WAY PACKAGE W/ MANUAL FLOW CONTROL

OPTIONS:

WATER COIL

- CHILLED WATER (CW)
- HOT WATER (HW)

COIL CONNECTION

- .625 O.D. = 1/2" NOM
- .875 O.D. = 3/4" NOM
- 1.125 O.D. = 1.0" NOM

STANDARD ATC SIZE

- STD = YES
- NON = NO

VALVE BODY SIZE

- 1/2" (X)
- 3/4" (Y)
- 1" (Z)

ACTUATOR CONTROL

- ON/OFF @ 120 VOLT (120)
- ON/OFF @ 24 VOLT (024)
- ON/OFF @ 208 VOLT (208)
- ON/OFF @ 230 VOLT (230)
- ON/OFF @ 277 VOLT (277)
- FLOATING POINT (FLP)
- MODULATING (MOD)

FLOW RATE (SELECT ONE)

- | | | | | |
|--------------------------------|--------------------------------|--------------------------------|--------------------------------|--------------------------------|
| <input type="checkbox"/> 00.50 | <input type="checkbox"/> 01.63 | <input type="checkbox"/> 03.50 | <input type="checkbox"/> 07.50 | <input type="checkbox"/> 14.00 |
| <input type="checkbox"/> 00.63 | <input type="checkbox"/> 01.75 | <input type="checkbox"/> 04.00 | <input type="checkbox"/> 08.00 | <input type="checkbox"/> 15.00 |
| <input type="checkbox"/> 00.75 | <input type="checkbox"/> 02.00 | <input type="checkbox"/> 04.50 | <input type="checkbox"/> 09.00 | <input type="checkbox"/> 16.00 |
| <input type="checkbox"/> 01.00 | <input type="checkbox"/> 02.25 | <input type="checkbox"/> 05.00 | <input type="checkbox"/> 10.00 | <input type="checkbox"/> 17.00 |
| <input type="checkbox"/> 01.13 | <input type="checkbox"/> 02.50 | <input type="checkbox"/> 05.50 | <input type="checkbox"/> 11.00 | <input type="checkbox"/> 18.00 |
| <input type="checkbox"/> 01.25 | <input type="checkbox"/> 03.00 | <input type="checkbox"/> 06.00 | <input type="checkbox"/> 12.00 | <input type="checkbox"/> 19.00 |
| <input type="checkbox"/> 01.50 | <input type="checkbox"/> 03.25 | <input type="checkbox"/> 07.00 | <input type="checkbox"/> 13.00 | |

MAXIMUM FLOW AND CLOSE OFF PRESSURE (PSI)			
VALVE SIZE	INT./DELUXE		MAX GPM FOR NSA
	GPM	PSI	
1/2"	5.00	44	4.00
3/4"	9.00	44	7.00
1"	19.00	22	11.00

VALVE SIZE CV	
VALVE SIZE	INTERMED. 3 WAY
1/2"	2.5
3/4"	4.1
1"	7.0

STANDARD ATC SIZE	
STDANDARD VALVE SIZE	INT./DELUXE FLOW RANGE
1/2"	0.50–5.00
3/4"	5.00–12.00
1"	12.00–19.00

NOTES:

- ON/OFF ACTUATOR CONTROL (24V, 120V, 208V, 230V, 277V) ARE SPRING RETURN EQUIPPED.
- TRUNK CONNECTION WILL MATCH COIL CONNECTION SIZE.
- COIL CONNECTIONS ARE FEMALE SWEAT, TRUNK CONNECTIONS ARE FEMALE NPT.
- 1" PIPING PACKAGES AND ATC AVAILABLE FOR HIGH PERFORMANCE (FCHCHP, FCHCHPLP) UNITS ONLY.
- IF WATER FLOW EXCEEDS 19 GPM PLEASE CONTACT FACTORY.
- ALL VALVES ARE NORMALLY CLOSED (NC), PLEASE CONTACT FACTORY IF NORMALLY OPEN (NO) IS REQUIRED.
- GPM MUST BE SELECTED ON PACKAGES AS CLOSE TO YOUR DESIGN GPM TO ENSURE PROPER CV ON BALANCING VALVE IS RECEIVED.
- INTERMEDIATE PACKAGES ARE ASSEMBLED AND TESTED, THEN SHIPPED SEPARATE FOR FINAL FIELD INSTALLATION BY OTHERS.
- BYPASS AND PIPE EXTENSION BY OTHERS.
- ATC IS SIEMENS STANDARD, HOWEVER OTHER ATCS CAN BE SUPPLIED AS SPECIAL.

ALL METRIC DIMENSIONS () ARE SOFT CONVERTED. IMPERIAL DIMENSIONS ARE CONVERTED TO METRIC AND ROUNDED TO THE NEAREST MILLIMETER.

PROJECT:		PRICE®	
ENGINEER:			
CUSTOMER:		251008	INTERMEDIATE HYDRONIC MANUAL VALVE PACKAGE, 3-WAY FAN COILS
SUBMITTAL DATE:	SPEC. SYMBOL:	2009/09/14	