

710,720 STAINLESS STEEL SUPPLY GRILLES & REGISTERS

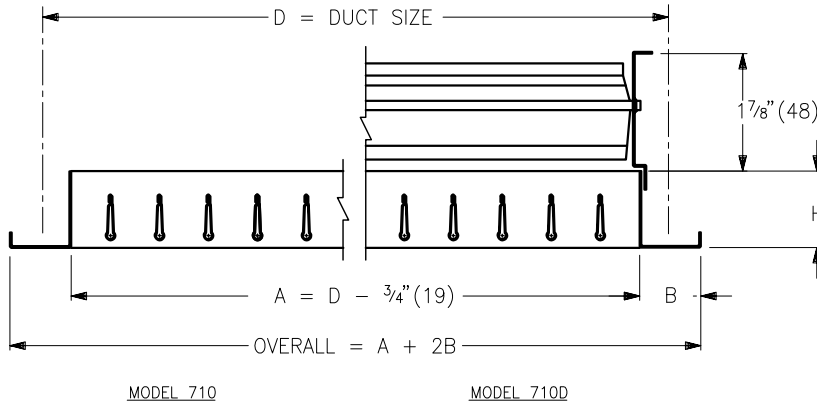

BORDERS:

F FLAT

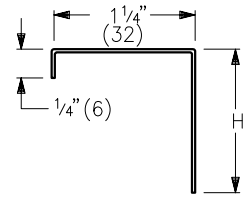

N NARROW

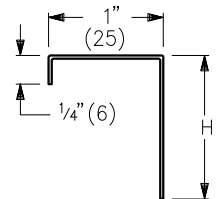

MOUNTING FRAMES:

D

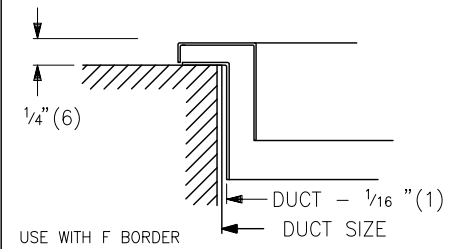

T

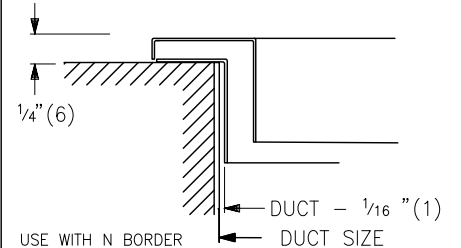

FINISH:

- FRAMES: #4 POLISHED FINISH
- BLADES: 2B FINISH

MATERIAL:

- FRAMES & BLADES: #304 STAINLESS STEEL

OPTION:

- C/W STAINLESS STEEL OPPOSED BLADE DAMPER(MILL FINISH) SPECIFY 710DSS OR 720DSS

CORE STYLES:

- 710/L**
- 710/S**

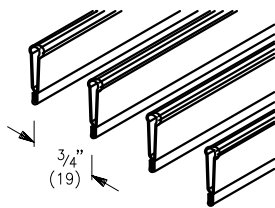

H = 1 1/4" (32)

- 720/L**
- 720/S**

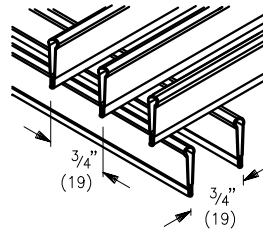

H = 2" (51)

NOTE:

- STANDARD CONSTRUCTION WITH A MULLION: A MULLION IS PROVIDED WHEN NOMINAL SIZE GRILLE DIMENSIONS EXCEED 24" (610). FOR UNEVEN NOMINAL SIZE DIMENSION. EG.45" X 6", THE MULLION IS POSITIONED 1/2" (12) FROM THE CENTRE OF THE GRILLE.
- LOUVRE BLADES – INDIVIDUALLY ADJUSTABLE.
- TYPE A FASTENING – COUNTERSUNK SCREW HOLES FOR NO.8 S.M.S. S/S PER FACTORY STANDARD. (SCREWS SUPPLIED)
- AVAILABLE SIZES – MIN.= 6" X 4" (152 X 101) MAX. ONE PIECE CONSTRUCTION 48" X 48" (1219 X 1219)
- OVERSIZE UNITS AVAILABLE C/W DUCT MOUNTING CHANNEL.
- BLADE ORIENTATION – FRONT SET
 - L = PARALLEL TO LONG DIMENSION
 - S = PARALLEL TO SHORT DIMENSION.

ALL METRIC DIMENSIONS () ARE SOFT CONVERTED. IMPERIAL DIMENSIONS ARE CONVERTED TO METRIC AND ROUNDED TO THE NEAREST MILLIMETER.

PROJECT:

ENGINEER:

CUSTOMER:

SUBMITTAL DATE:

SPEC. SYMBOL:

PRICE®

RV

219771

2010/02/09

710/720
STAINLESS STEEL SUPPLY
GRILLES & REGISTERS

730,735 STAINLESS STEEL RETURN GRILLES & REGISTERS

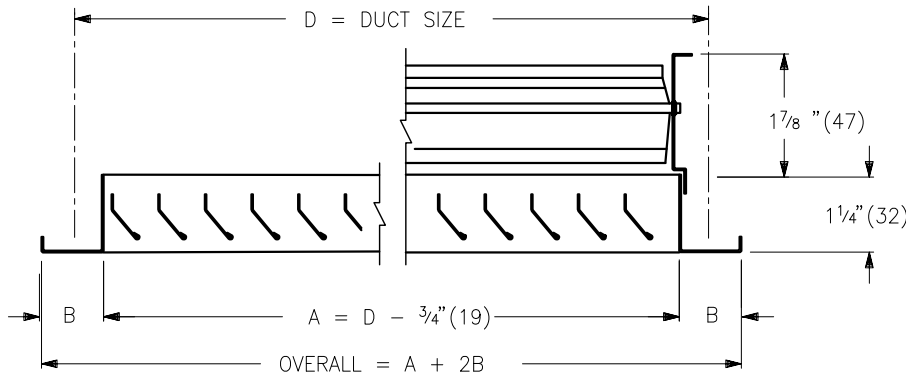

BORDERS:

F FLAT

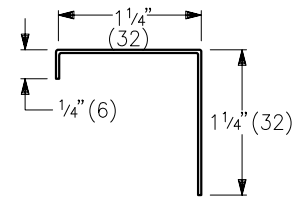

N NARROW

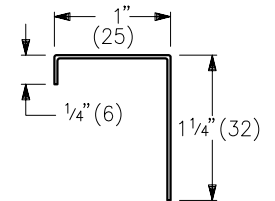

FINISH:

- FRAMES: #4 POLISHED FINISH
- BLADES: 2B FINISH

MATERIAL:

- FRAMES & BLADES: #304 STAINLESS STEEL

OPTIONS:

- C/W STAINLESS STEEL OPPOSED BLADE DAMPER(MILL FINISH) SPECIFY 730DSS OR 735DSS

NOTE:

- TYPE A FASTENING – COUNTERSUNK SCREW HOLES FOR NO.8 S.M.S. S/S PER FACTORY STANDARD. (SCREWS SUPPLIED)
- AVAILABLE SIZES – MIN.= 6" X 4" (152 X 101) MAX. ONE PIECE CONSTRUCTION 48" X 48" (1219 X 1219)
- OVERSIZE UNITS AVAILABLE C/W DUCT MOUNTING CHANNEL.
- BLADE ORIENTATION – FRONT SET
 - L = PARALLEL TO LONG DIMENSION
 - S = PARALLEL TO SHORT DIMENSION.

MOUNTING FRAMES:

D

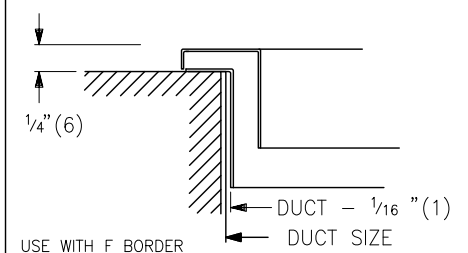

T

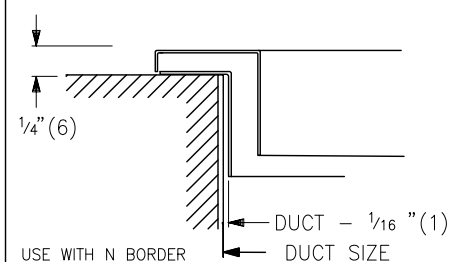

CORE STYLES:

- 730/L**
- 730/S**

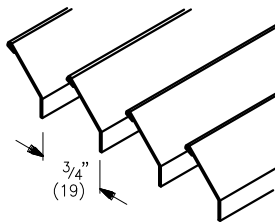

- 735/L**
- 735/S**

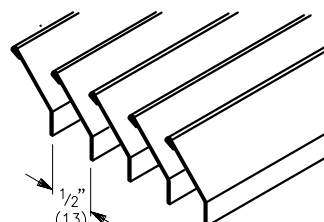

ALL METRIC DIMENSIONS () ARE SOFT CONVERTED. IMPERIAL DIMENSIONS ARE CONVERTED TO METRIC AND ROUNDED TO THE NEAREST MILLIMETER.

PROJECT:

ENGINEER:

CUSTOMER:

SUBMITTAL DATE:

SPEC. SYMBOL:



730/735

219780

STAINLESS STEEL RETURN GRILLES & REGISTERS

2010/09/03