

**LV1 LINEAR VANE DIFFUSER ONE-WAY**

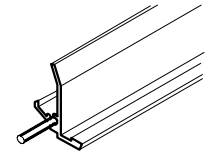

MULTIPLE SECTION ALIGNMENT PIN

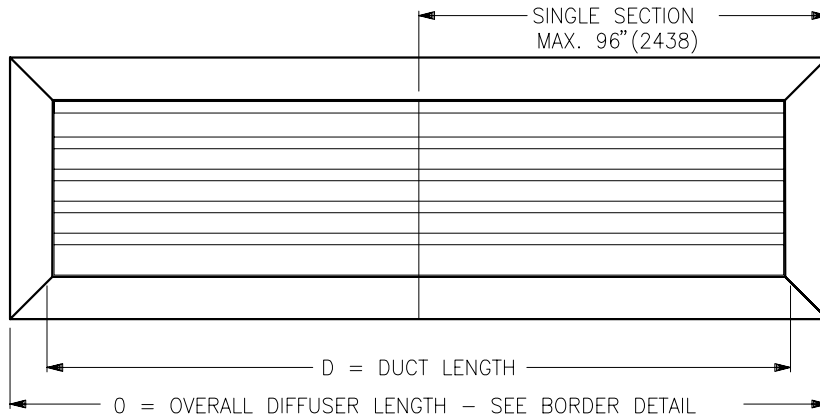
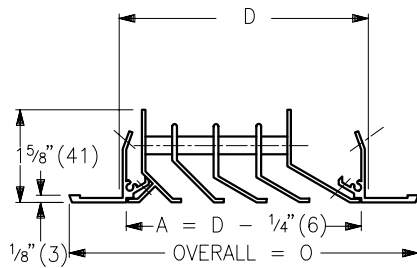

**LV1**

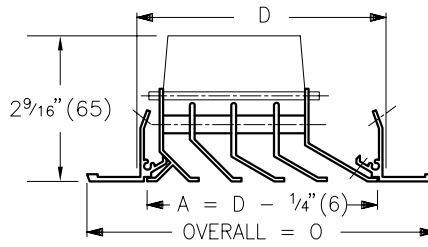

**LV1/DV1**  
c/w 1" o/c DIRECTIONAL VANES

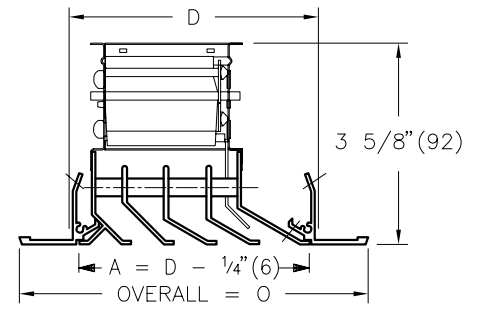

**LV1/3**  
c/w OPPOSED BLADE DAMPER.

**BORDER**

- 500**  
1/2" (13)  
FACE WIDTH
- 1000**  
1" (25)  
FACE WIDTH

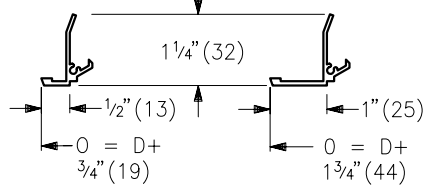

- 062F**  
1/16" (2)  
FLUSH MOUNTED

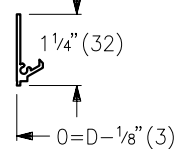

- 062**  
1/16" (2)  
PLASTER MOUNTED

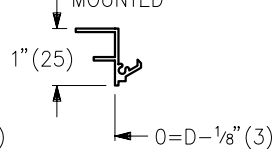

LISTED SIZE	D DUCT SIZE
3 1/2	3 5/8 (92)
4 1/4	4 3/8 (111)
5	5 1/8 (130)
5 3/4	5 7/8 (149)
6 1/2	6 5/8 (168)
8	8 1/8 (206)
9 1/2	9 5/8 (244)
11 3/4	11 7/8 (302)

**NOTES:**

- MATERIAL - EXTRUDED ALUMINUM.
- ONE-WAY DEFLECTION.
- FACTORY TOLERANCE. ± 1/32" (1)

**FINISH:**

- B12 WHITE  
(OPTIONAL FINISHES AVAILABLE)

ALL METRIC DIMENSIONS ( ) ARE SOFT CONVERTED. IMPERIAL DIMENSIONS ARE CONVERTED TO METRIC AND ROUNDED TO THE NEAREST MILLIMETER.

<b>PROJECT:</b>		<b>PRICE®</b>
<b>ENGINEER:</b>		
<b>CUSTOMER:</b>		<b>LV1</b>
<b>SUBMITTAL DATE:</b>		LINEAR VANE DIFFUSER ONE-WAY DEFLECTION
<b>SPEC. SYMBOL:</b>	210898	
	AUG 06	

**LV2 LINEAR VANE DIFFUSER TWO-WAY**

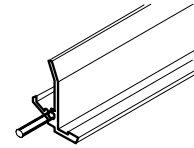
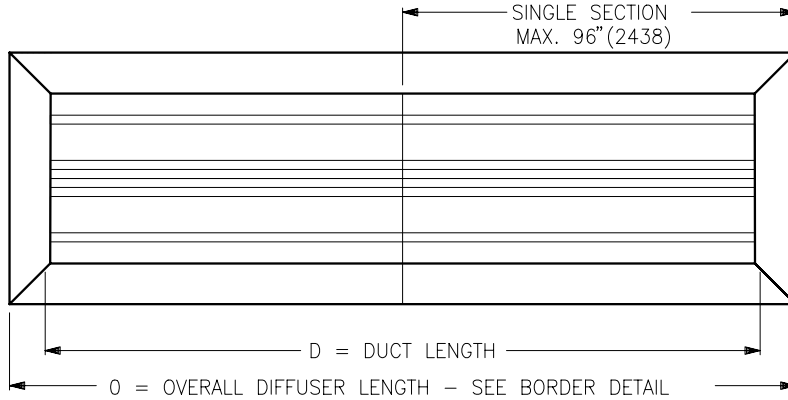

MULTIPLE SECTION ALIGNMENT PIN

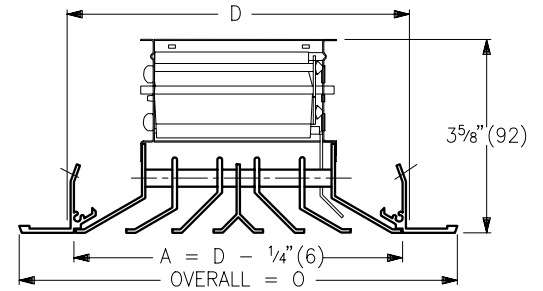
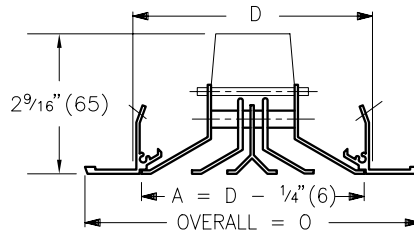
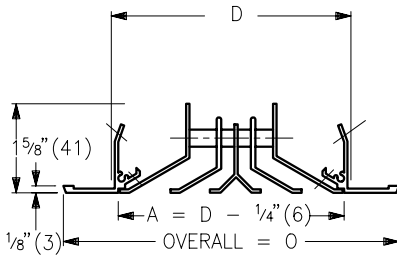

**LV2**

**BORDERS**

- 500**  
1/2" (13)  
FACE WIDTH
- 1000**  
1" (25)  
FACE WIDTH

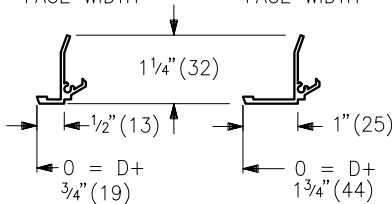

**NOTES:**

- MATERIAL – EXTRUDED ALUMINUM.
- FACTORY TOLERANCE.  $\pm 1/32$ " (1)

**LV2/DV**

c/w 1" o/c DIRECTIONAL VANES

**PLASTER FRAMES**

- 062F**  
1/16" (2)  
FLUSH MOUNTED
- 062**  
1/16" (2)

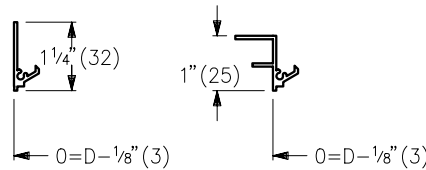

**LV2/3**

c/w OPPOSED BLADE DAMPER.

LISTED SIZE	D DUCT SIZE
6 1/4	6 3/8 (162)
7 3/4	7 7/8 (200)
9 1/4	9 3/8 (238)
10 3/4	10 7/8 (276)
12 1/4	12 3/8 (314)

**FINISH:**

- B12 WHITE  
(OPTIONAL FINISHES AVAILABLE)

ALL METRIC DIMENSIONS ( ) ARE SOFT CONVERTED. IMPERIAL DIMENSIONS ARE CONVERTED TO METRIC AND ROUNDED TO THE NEAREST MILLIMETER.

<b>PROJECT:</b>		<b>PRICE</b> <sup>®</sup>	
<b>ENGINEER:</b>		<i>Darl</i>	<b>LV2</b>
<b>CUSTOMER:</b>		210899	LINEAR VANE DIFFUSER TWO-WAY DEFLECTION
<b>SUBMITTAL DATE:</b>	<b>SPEC. SYMBOL:</b>	MAY 97	