



PRICE®

PRICE ▶ GENESIS®
**FAN POWERED
CONSTANT VOLUME
QUIET TERMINAL UNITS
SERVICE & INSTALLATION MANUAL**



Date: 04/11
Reference #: F-54

Contents

General	3
Control Assembly Label	4
Receiving Inspection	4
Installation	5-7
Maintenance	7
Multiaccess Configuration	8
Air Balancing Procedure/ECM Motor Adjustment	8-9
Fan Performance Curves	10-13
Electronic Airflow Adjustment Procedures	14
Electronic Calibration Curves	15
Pneumatic Calibration Procedures.....	16-17
Digital Calibration Procedures	18
Pneumatic & Digital Calibration Curves	19
Troubleshooting	20
Replacement Parts List	21

General

Price fan powered terminals are available with pneumatic, electronic or direct digital (DDC) controls. In most cases pneumatic and electronic controls are factory supplied and mounted. In the case of DDC controls, the terminal unit controls are often supplied by the controls contractor and either factory or field mounted. For information concerning controls, components, sequence of operations, etc. for DDC controls supplied by the controls contractor, please refer to the documentation provided by the controls contractor.

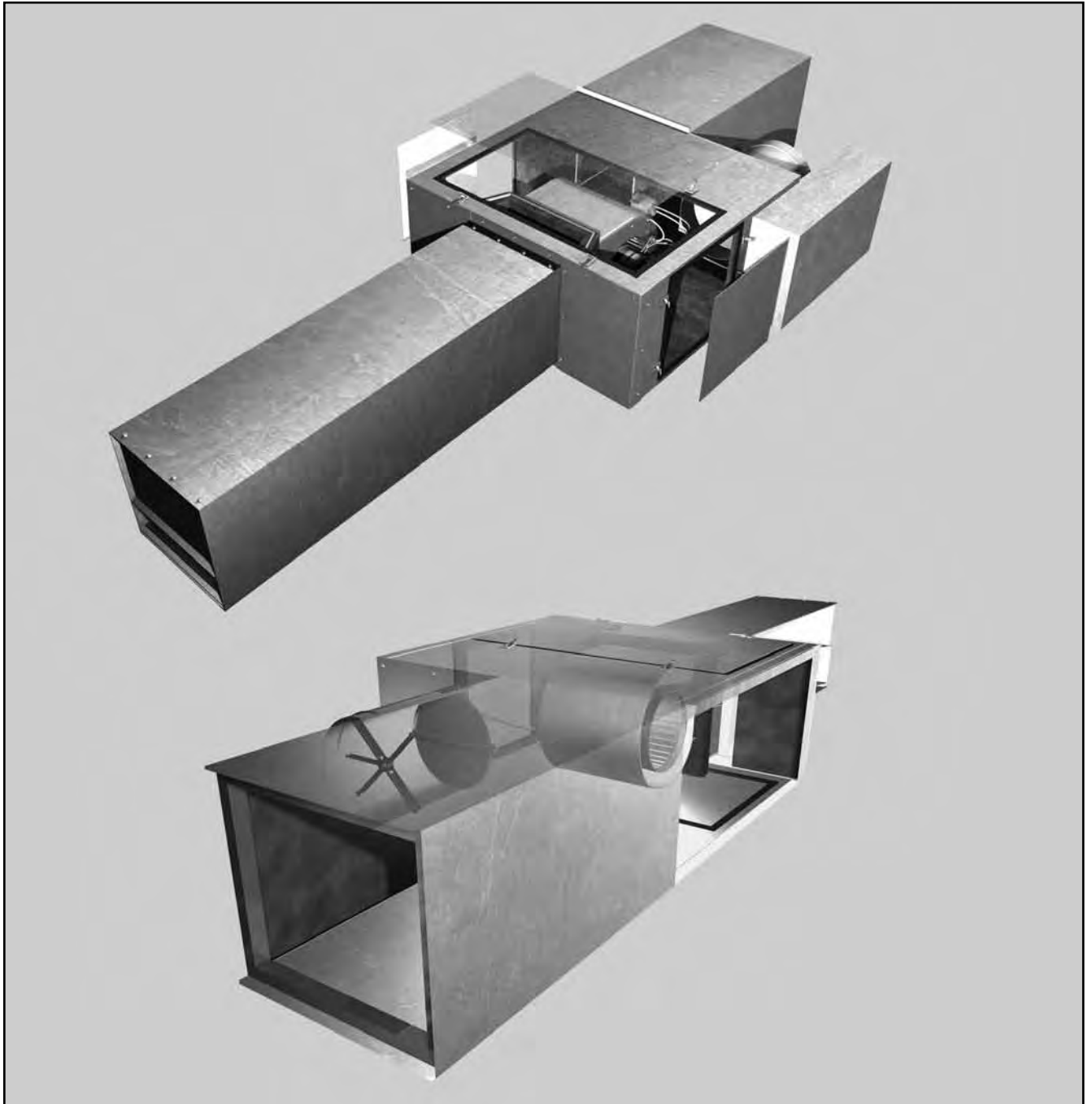

Damper rotation is always clockwise to the open position. An identification mark on the end of the shaft indicates the damper position. Capped tees are provided in sensing lines from the amplifying sensor. These allow field connection of a differential pressure gauge for accurate air flow measurement. (Not included with electronic controls.)

Control Assembly Label



VAV SPECIFICATIONS /
SPÉCIFICATIONS VAV

Price Order No / No Comm de Price:	54399
Branch PO / BC de la Succé:	T100200J
Customer PO / BC du Client:	3429
Job Name / Nom du Projet:	CommerceTrust
Package Tag / Étiquette du Colis:	
Unit Location / Localisation de l'Unité:	VAV-59

AIR FLOW /
DIRECTION DE L'AIR



INSTALLED /
INSTALLÉ:



AIR DISTRIBUTION PRODUCTS /
PRODUITS DE DISTRIBUTION D'AIR

Manufactured By / Fabriqué Par
Price

Special Instructions / Instructions Spéciales: SCHEM #CX49210

Fan Flow = 250 cfm

Item	Model / Modèle	Size / Grandeur	Controller / Régulateur	Motor / Moteur
1	FPCGQ	2008	CP101 Controller	EHP

Air Volume (cfm / l/s) / Volume d'Air (pcm / l/s)		Reset Span / Plage d'Opération	Damper / Volet	Thermostat	Coil Serpentin	Application
Min.	Max.					
0	500 cfm	8-13 psi	N.O.	Direct Acting		Cooling
0	236 L/s					

031600

All Price fan powered terminal units are tagged with a control assembly label as shown on the left. This label identifies the model number, location tag #, controller type, actuator type, thermostat action, damper action, application and controller setpoints. Options, accessories and appropriate control diagrams are also identified. If field adjustment of the controller factory set points should become necessary, follow the appropriate procedure outlined in the manual. Note that all pneumatic controls must be calibrated in the position they are mounted

All factory supplied controllers are tagged with a controller label as shown below. This label identifies the required sensor velocity pressure for both the minimum and maximum controller setpoints.

Price Order No. / No. de Comm. de Price	Item	Model / Modèle	Size / Grandeur	Unit Location / Localisation de L'Unité
54399	1	FPCGQ8000	2008	VAV-59
	Damper / Volet	Air Volume (cfm / l/s) / Volume d'air (pcm / l/s)	Settings / Réglages	Reset Span / Plage d'Opération
	N.O.	0 cfm 500 cfm 0 L/s 236 L/s	0.000 0.28" V.P. 0 71 Pa	8-13 psi

Caution To Contractors

1. Fan powered terminal units are not intended for use as temporary heat or ventilation sources during building construction. The terminal units are not designed nor equipped to operate in a dusty construction environment. Recirculating fan wheels can become coated in construction dust, resulting in an unbalanced wheel. This in turn can contribute to reduced motor life. Inlet air filters, if supplied, would provide little protection as they would quickly become plugged with construction dust.
2. A fan powered terminal unit should never be operated if the downstream duct work has not been installed. A minimum of 0.10 inches W.G. downstream static pressure resistance is required for safe operation of the fan motor. Unit with electric heater requires 0.20 inches W.G..

Please note that Price cannot warrant against unauthorized operating conditions as outlined above.

Receiving Inspection

All Price fan powered terminal units are inspected before shipment. After unpacking the assembly, check it for damage. If any damage to the products is found, report it immediately to the delivery carrier. During unpacking and installation, **do not handle the unit by the inlet velocity sensor**. Caution is required when unpacking the fan powered units with electric coils as not to damage the elements.

WARNING: DO NOT ADJUST THE CONTROL COMPONENTS

Installation

FDCGQ unit arrives at the job site in 3 separate pieces - the basic unit, discharge silencer, and inlet attenuator. Factory provides installation angles that need to be screwed to assemble the whole unit.

Note: The silencer section has to be installed so the blower outlet opening and silencer inlet opening are aligned. Otherwise the airflow path will be blocked and the unit will not provide desired air flow nor sound performance.

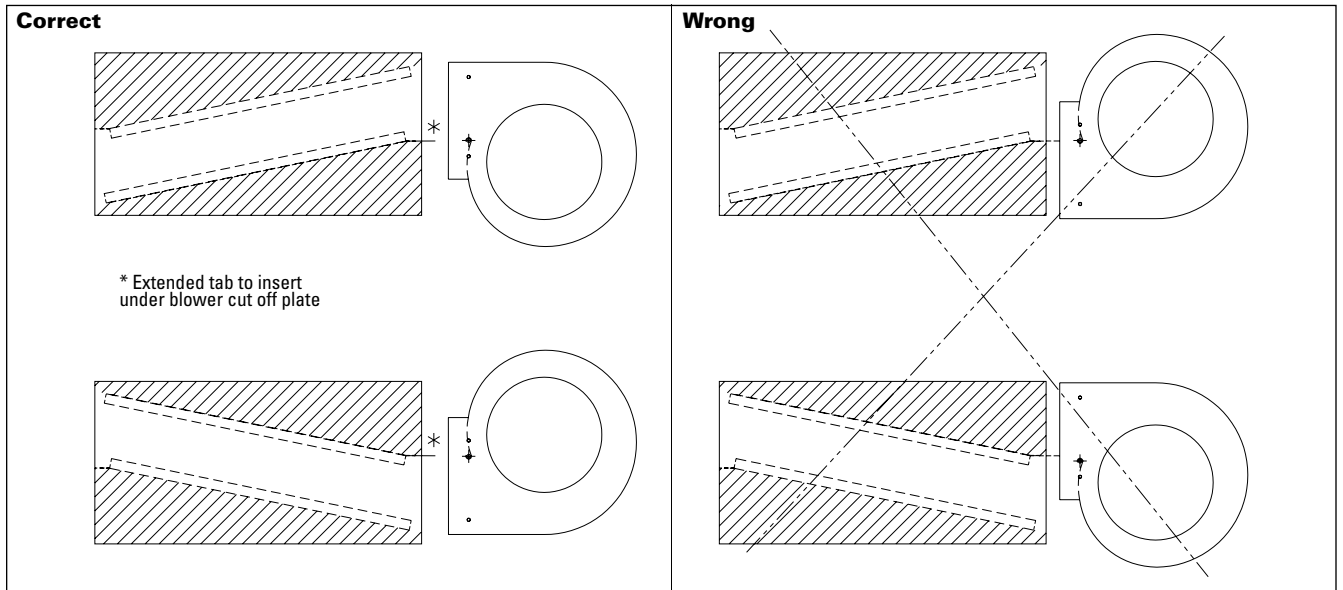
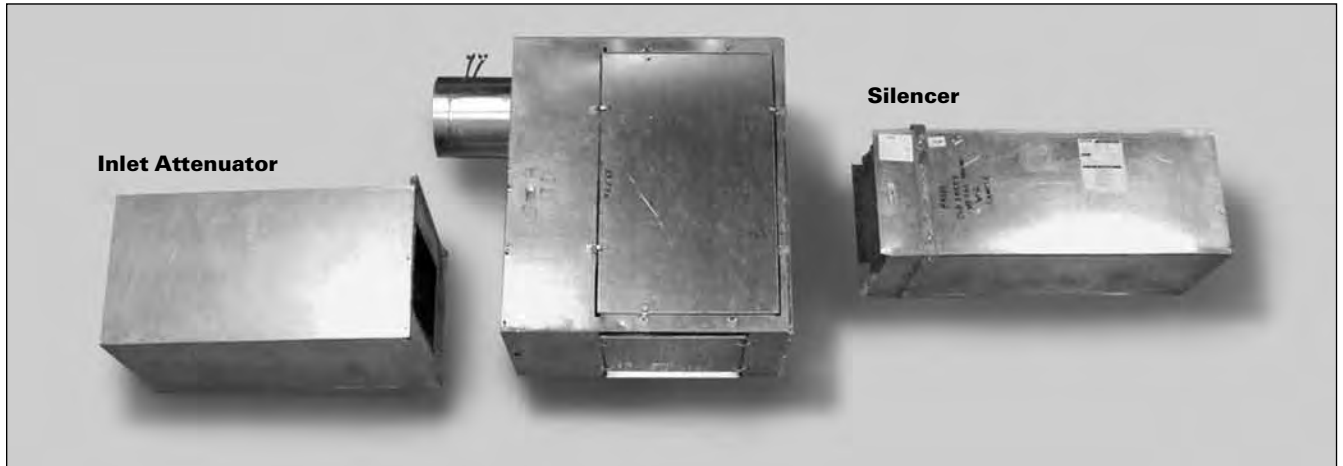

Installation

Mounting The Unit

1. Use trapeze hangers or optional factory mounted hanger brackets as illustrated. Hanging rods should be securely attached to joists or to mounting anchors which are properly secured to slab construction with lugs or poured in place anchors. Trapeze bars should be positioned within 3 inches (76 mm) of the discharge end and 6 inches (152 mm) of the inlet end to allow for access panel removal.
2. Price Fan Powered Terminal Units are designed to be mounted in the direction indicated by the Control Assembly Label found on the protective shroud.
3. Do not block the bottom access panel, maintain clearance for blower service. Correct installation of the trapeze bars will not block access panel removal.
4. Do not install tight to slab, avoid contact with other obstacles such as rigid conduit and sprinkler piping. This can cause excessive vibration and noise transmission.
5. Install the unit in a location that allows free access to the unit as well as all control components.
6. Ensure main power to the terminal and electric coil has been disconnected prior to performing any electrical work or inspection of the circuitry.
7. **WARNING:** Do not tamper with control components.

Optional Hanger Brackets

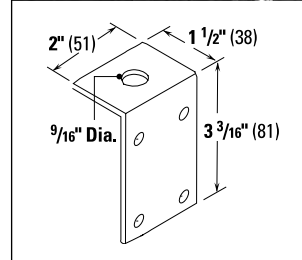

Optional Spring Hanger Brackets

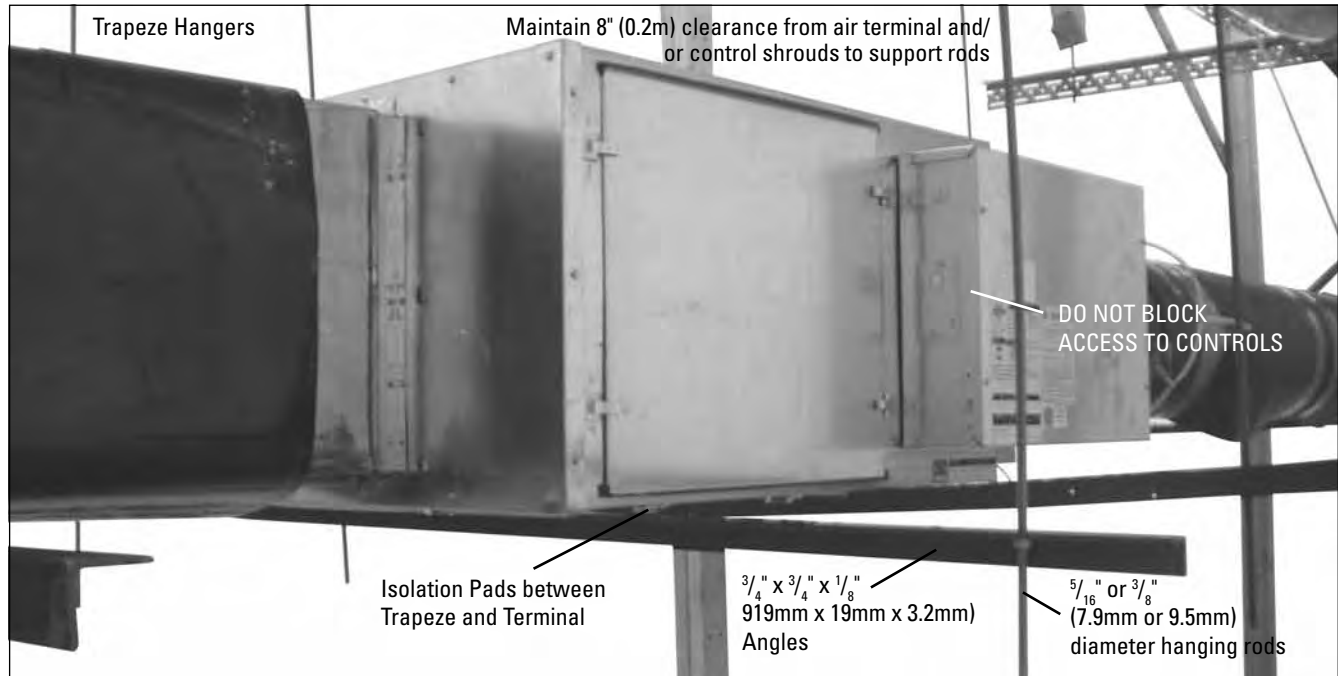
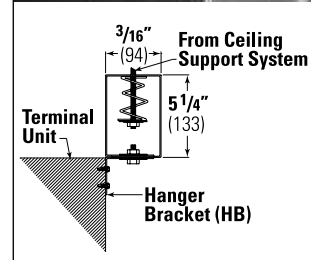

Duct Connection

1. Recommend a minimum of 3 duct diameters of straight inlet duct, either sheet metal or flexible, same size as the inlet, between the unit inlet and any transition, take-offs or fittings. Use of transitions or elbows at the unit inlet to be avoided. Where flexible duct is used it should be pulled tight to eliminate sags or folds.
2. To control radiated noise in critical applications it is recommended that the inlet ducts be fabricated of minimum 24 gauge sheet metal in place of flexible duct.
3. To prevent excessive air leakage, all cleat joints should be sealed with an approved duct sealer. This applies to all accessory connections as well as the basic fan powered terminal unit.
4. Holes that are drilled in the duct for testing or balancing purposes are to be sealed with duct tape or duct sealer.
5. For motors a minimum of 0.1" W.G. downstream static pressure is required to prevent overheating of the fan motor. For units with electric heaters a minimum of 0.2" W.G. is required.

Electrical Connection

CAUTION: Disconnect all incoming power before any electrical installation or service is performed on the unit(s).

1. All field wiring is to be in accordance with the National Electrical Code ANSI/NFPA No. 70 or the Canadian Electrical Code, Part 1, CSA Standard C 22.1.
2. Refer to the product identification label on each unit for information to determine the field wire size.
3. Check voltage requirements prior to power supply connection. Refer to the electrical label located near the electrical control box and also refer to the schematic drawing provided on the underside of the electrical control box cover.
4. If upon energizing the electric motor excessive noise is apparent, shut down the unit. Determine the cause by checking for packing materials, etc. and re-energize after corrective action has been taken.
5. If an Electric Reheat Coil has been supplied, refer to the electrical schematic which is permanently affixed to the underside of the electrical control cabinet door, prior to hook-up. Check the voltage requirements to ensure proper voltage supply is used.

Caution: For three phase power connections, be sure to account for fan motor load. Phases must be balanced accordingly.

Control Connections

Pneumatic

1. External control air connections are provided for main air and thermostat hook up. These are to be piped according to the label on the inlet panel.
2. Main air supply must be clean and dry, delivered at 15 to 25 psi (maximum 25 psi).
3. Ensure that lines are not crimped or cut when installed.

Electronic

A wiring diagram is provided with each assembly. Follow the diagram for wiring of the thermostat and other accessories.

Digital

If controls have been factory mounted, a wiring diagram will be included with the unit indicating the factory mounted components. For field wiring of room sensors and other accessories, refer to the controls contractor's documentation for all wiring information.

Maintenance

Fan and Motor

1. Disconnect all incoming power before servicing the unit.
2. Price fan powered terminal units are supplied with permanently lubricated motors.
3. The blower and motor should be inspected annually for accumulation of dust and dirt. Clean as necessary.

CAUTION: MOTOR MAY BE VERY HOT. ENSURE MOTOR HAS COOLED BEFORE SERVICE.

4. Motors are provided with thermal overload protection. If the motor overheats and trips the thermal overload, it will automatically reset after cooling down to a proper operating temperature.
5. If the fan motor is turned off while the primary air system is operational the following start-up procedure should be employed for constant volume units.
 - a. Override the primary air damper to the closed position as follows:
 - Pneumatic** - Apply main air to the damper actuator for normally open units or disconnect main air for normally closed units.
 - Electronic** - Disengage gears of the electric actuator with the clutch button and manually close damper.
 - DDC** - Use DDC software to override damper.
 - b. Wait at least 2 minutes to allow the fan wheel to stop rotation.
 - c. Turn power on to the terminal unit
 - d. Restore damper to normal position. The above procedure will prevent backward rotation of the fan motor on start-up.
6. If field amperage draw readings of the fan motor are required, measurements should be taken with a true RMS meter. Non-true RMS meters will not provide accurate reading due to alteration of the sine wave by the fan speed control. Refer to Page 8 for maximum motor operating amps.

Filter(s)

1. Filters, if supplied, should be replaced or removed after system start-up.
2. If filters are used beyond system start-up they should be changed regularly to avoid excessive restriction of air flow. Frequency would depend on environment.
3. Contact your Price representatives for details on replacement filter media.

Air Balancing Procedure

Before Air Balancing the terminal unit, the following general items should be verified.

1. The primary fan system is operating at the specified volume, static pressure, RPM and current.
2. Return filters (if supplied) are clean.
3. All balancing dampers are adjusted and locked. Dampers downstream of the terminal unit should be proportionally balanced.
4. Thermostats are calibrated and operational.
5. All duct work and connections are free from leaks.
6. Sufficient duct static pressure is available at the terminal primary air inlet.
7. All diffusers are installed and adjusted for the proper air pattern.
8. For motors a minimum of 0.1" W.G. downstream static pressure is required to prevent overheating of the fan motor. For units with electric heaters a minimum of 0.2" W.G. is required.
9. The primary air volume (both minimum and maximum set points) are factory calibrated for pneumatic or electronic controls supplied by Price. If field adjustment should be necessary, follow the appropriate calibration procedures for the controller type supplied with the unit. If DDC controls are supplied, refer to the control contractor's documentation for calibration instructions.
10. Set the thermostat to full cooling. The fan should be on and the primary air valve at maximum air flow. Verify the air flow with the sensor tube or pitot tube traverse. Adjust if necessary.
11. The fan volume must be field adjusted with the fan speed controller. Fan curves on page 8 indicate the volume range of each size unit. Adjust the speed control until the desired air flow is measured at the outlet.
12. Set the thermostat to full heating. The fan should be on and the primary air valve at minimum flow. Verify the primary air volume with sensor taps or pitot tube traverse. Adjust if necessary.
13. Always set the fan volume at full cooling.

Operating Guidelines

1. For motors a minimum of 0.1" W.G. downstream static pressure is required to prevent overheating of the fan motor. For units with electric heaters a minimum of 0.2" W.G. is required.
2. If electric duct heaters are supplied, 70 CFM/kW minimum air flow across the heater must be maintained.
3. If electric duct heaters are supplied, the discharge air temperature must not exceed 120°F.
4. A proper central system start-up sequence should be employed for constant volume units. If the central system is turned off at night or weekends, the following start-up sequence is suggested to prevent the terminal fans from operating in a reverse rotation.
 - a. All terminal fans are energized at least two minutes before the central fan system is turned on.
 - b. The central fan should be started at low flow and slowly ramped up to design flow over a two minute minimum time frame.

Multi-access Configuration

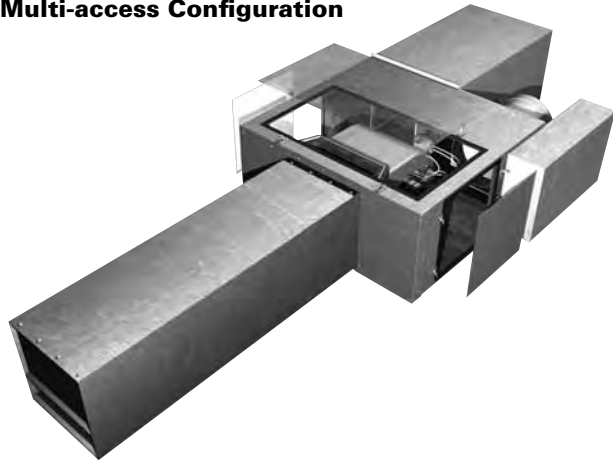

PRICE Genesis features 4 large gasketed access panels not obstructed by controls. Each panel (top, bottom, left and right hand side) are large enough to service motor/blower assembly.

Each panel is equipped with tool-tree shop compression latches for fast access.

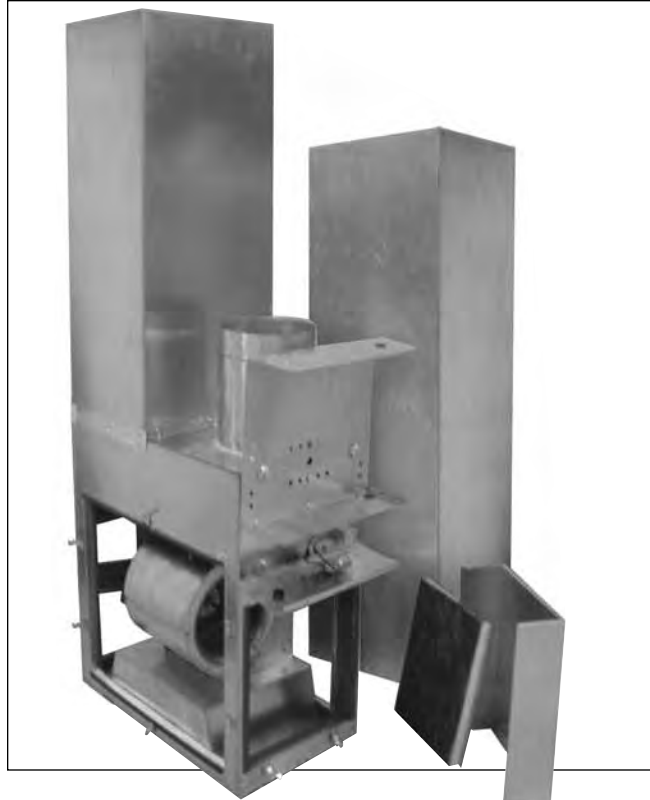
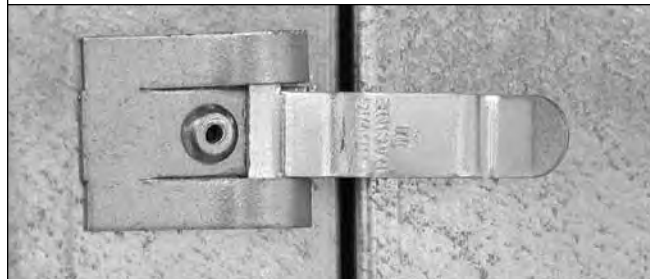

ECM Motor Adjustment

1. Remove the electrical control cover and connect the leads from a DC voltmeter to the terminals indicated.
2. Determine test point voltage from the formula based on the desired air flow.
3. Adjust the manual speed control dial on the outside of the box with a screwdriver until the test point voltage is achieved.
4. Wait a few seconds for the ECM motor to adjust its speed and then verify fan flow with measurements at the supply outlets.
5. If necessary, fine tune the speed control in accordance with the measured outlet flow.

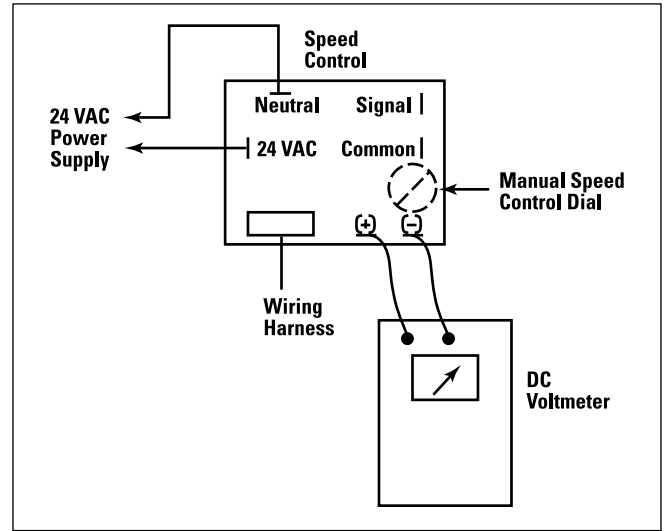

FDCGQ Genesis, Voltage vs. CFM Equations

Unit Size	Motor Voltage	ECM SC Voltage vs CFM Equation
10, 20	120	no equation, flow set in the field
	240	
	277	
30	120	CFM = 387.39(Vdc) - 309.96
	240	CFM = 388.58(Vdc) - 304.72
	277	CFM = 370.89(Vdc) - 265.85
40	120	CFM = 593.1(Vdc) - 666.86
	240	CFM = 550.88(Vdc) - 587.79
	277	CFM = 580.39(Vdc) - 644.1
50	120	CFM = 659.06(Vdc) - 529.65
	240	CFM = 652(Vdc) - 502.58
	277	CFM = 672.29(Vdc) - 572.45
60	120	CFM = 1043.9(Vdc) - 956.31
	240	CFM = 1031.1(Vdc) - 884.03
	277	CFM = 1022.3(Vdc) - 921.1
70	120	CFM = 1170.2(Vdc) - 1004.4
	240	CFM = 1193.7(Vdc) - 1064.9
	277	CFM = 1188.6(Vdc) - 991.88

Fan Performance Curves - PSC Motor

Unit Size 20

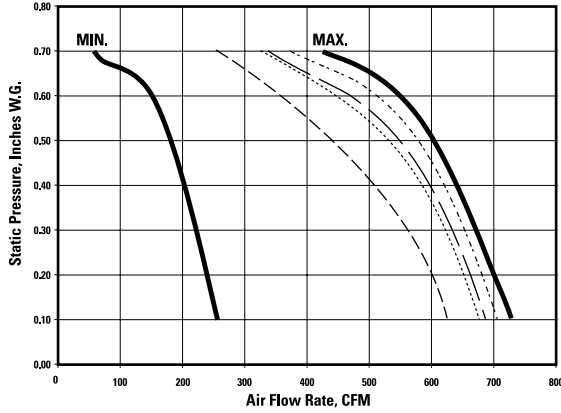

Unit Size 30

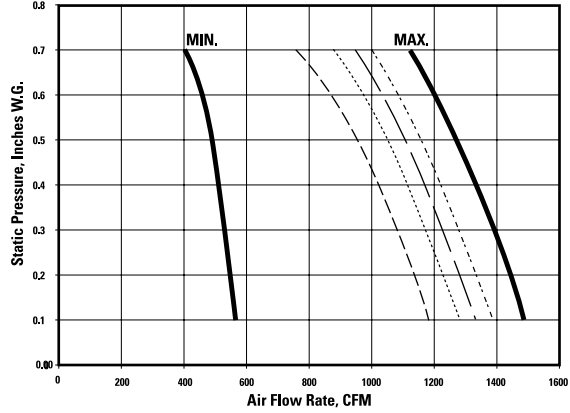

Unit Size 40

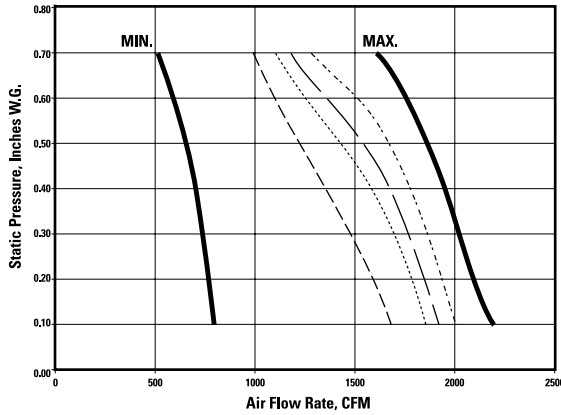

Unit Size 50

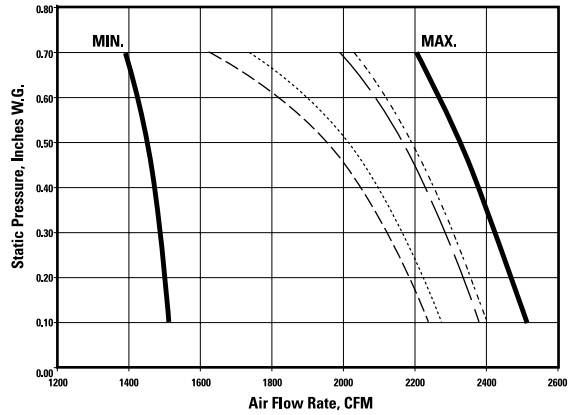

Unit Size 60

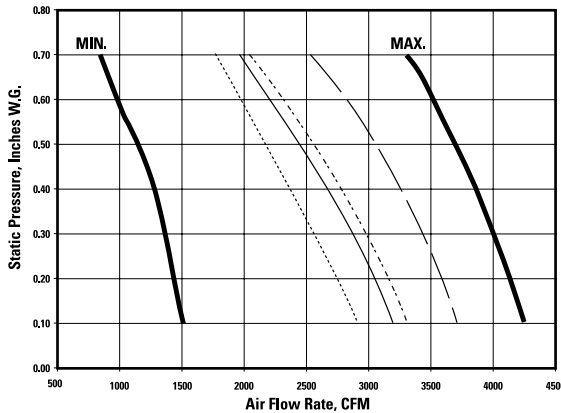

Unit Size 70

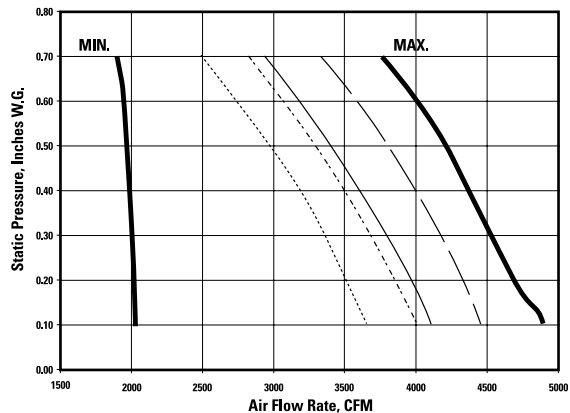

Caution to Contractors

Fan powered terminal units are not intended for use as temporary heat or ventilation during building construction. The terminal units are not designed nor equipped to operate in a dusty construction environment. Recirculating fan wheels can become coated with construction dust, resulting in an unbalanced wheel. This in turn can contribute to reduced motor life. Inlet air filters would provide little protection as they would quickly become plugged with construction dust.

A fan powered terminal unit should never be operated if the downstream ductwork has not been installed. A minimum of 0.1" W.G. downstream static pressure resistance is required for safe operation of the fan motor. For units with electric heaters a minimum of 0.2" W.G. is required.

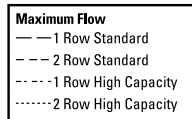

Please Note: Price cannot warrant against unauthorized operation under conditions as outlined on this page.

Fan Performance Curves - ECM Motor

Unit Size 20 - No Coil

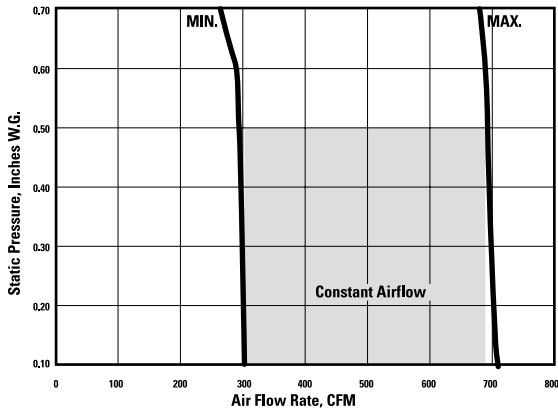

Unit Size 30 - No Coil

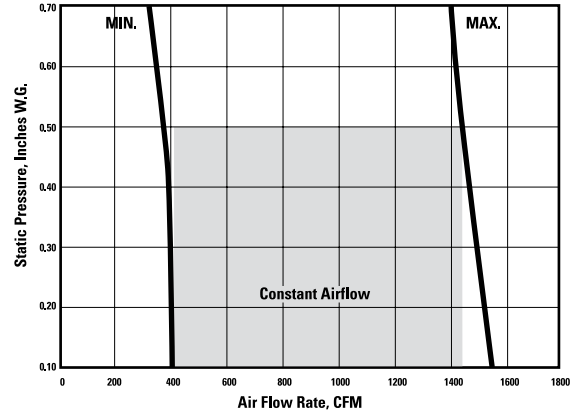

Unit Size 20 - 1 Row Coil

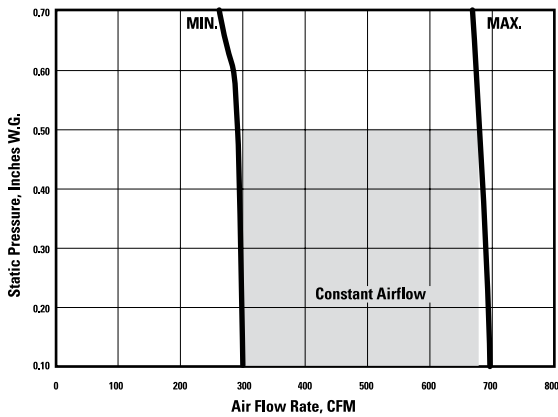

Unit Size 30 - 1 Row Coil

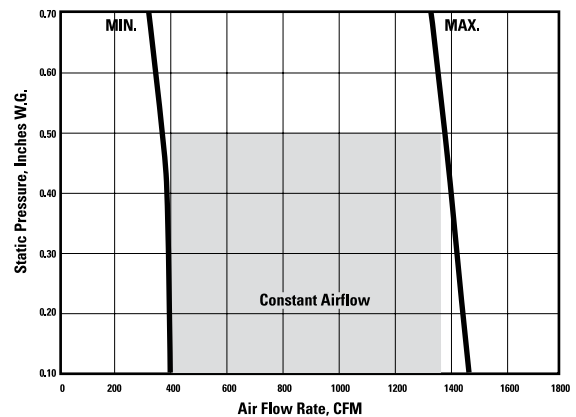

Unit Size 20 - 2 Row Coil

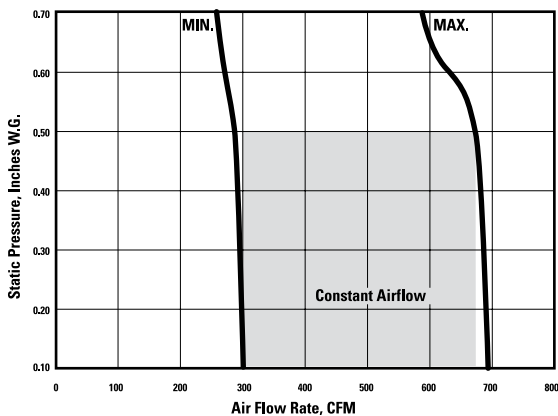

Unit Size 30 - 2 Row Coil

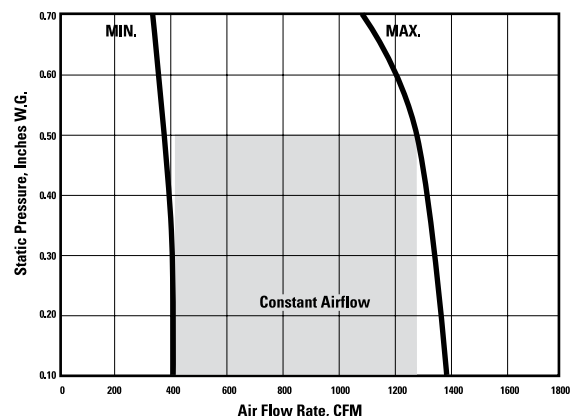

Caution to Contractors

Fan powered terminal units are not intended for use as temporary heat or ventilation during building construction. The terminal units are not designed nor equipped to operate in a dusty construction environment. Recirculating fan wheels can become coated with construction dust, resulting in an unbalanced wheel. This in turn can contribute to reduced motor life. Inlet air filters would provide little protection as they would quickly become plugged with construction dust.

A fan powered terminal unit should never be operated if the downstream ductwork has not been installed. A minimum of 0.1" W.G. downstream static pressure resistance is required for safe operation of the fan motor. For units with electric heaters a minimum of 0.2" W.G. is required.

Please Note: Price cannot warrant against unauthorized operation under conditions as outlined on this page.

Fan Performance Curves - ECM Motor

Unit Size 40 - No Coil

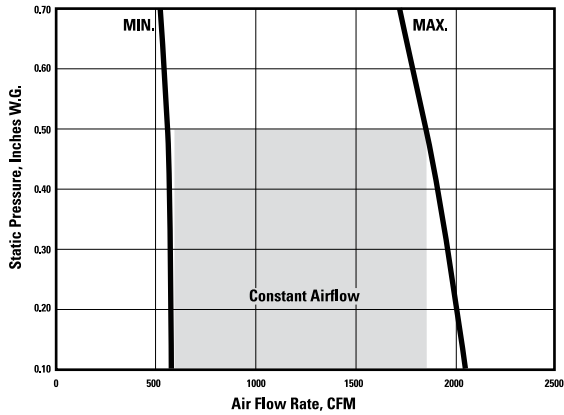

Unit Size 50 - No Coil

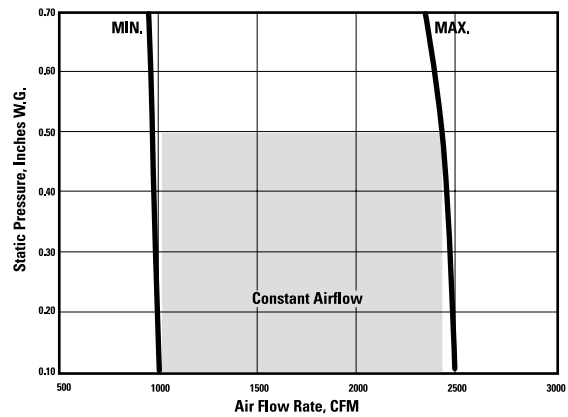

Unit Size 40 - 1 Row Coil

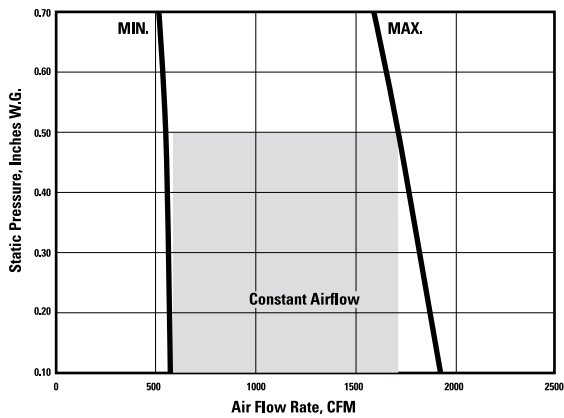

Unit Size 50 - 1 Row Coil

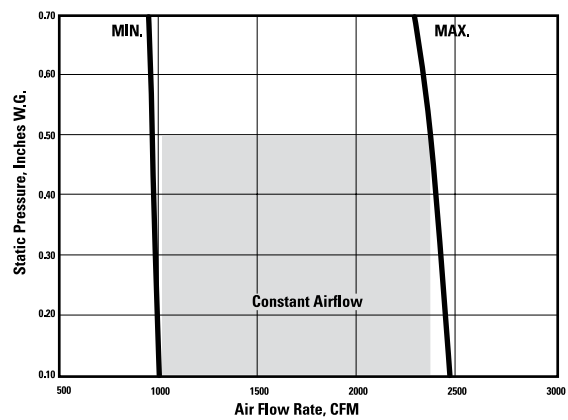

Unit Size 40 - 2 Row Coil

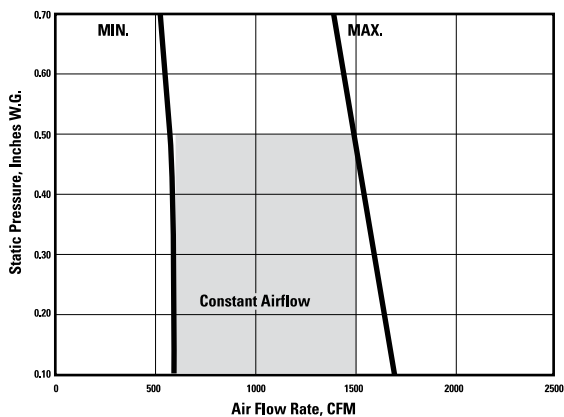

Unit Size 50 - 2 Row Coil

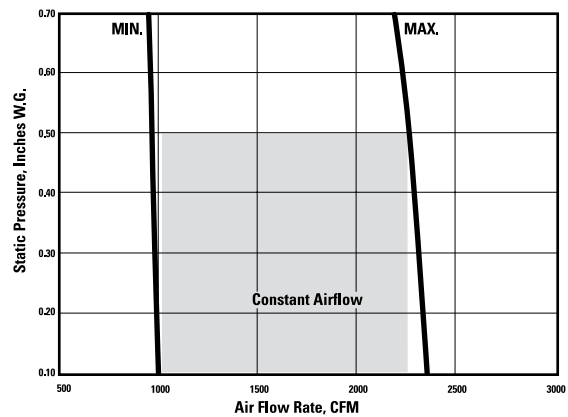

Caution to Contractors

Fan powered terminal units are not intended for use as temporary heat or ventilation during building construction. The terminal units are not designed nor equipped to operate in a dusty construction environment. Recirculating fan wheels can become coated with construction dust, resulting in an unbalanced wheel. This in turn can contribute to reduced motor life. Inlet air filters would provide little protection as they would quickly become plugged with construction dust.

A fan powered terminal unit should never be operated if the downstream ductwork has not been installed. A minimum of 0.1" W.G. downstream static pressure resistance is required for safe operation of the fan motor. For units with electric heaters a minimum of 0.2" W.G. is required.

Please Note: Price cannot warrant against unauthorized operation under conditions as outlined on this page.

Fan Performance Curves - ECM Motor

Unit Size 60 - No Coil

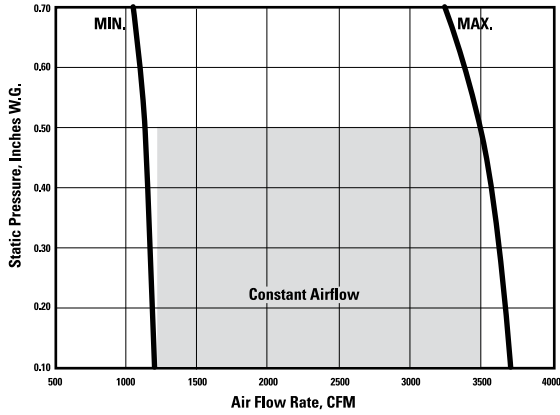

Unit Size 70 - No Coil

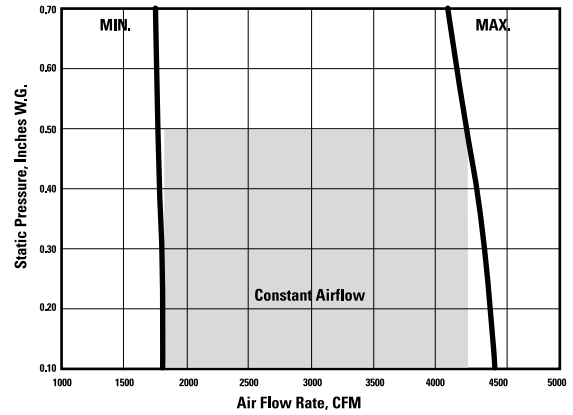

Unit Size 60 - 1 Row Coil

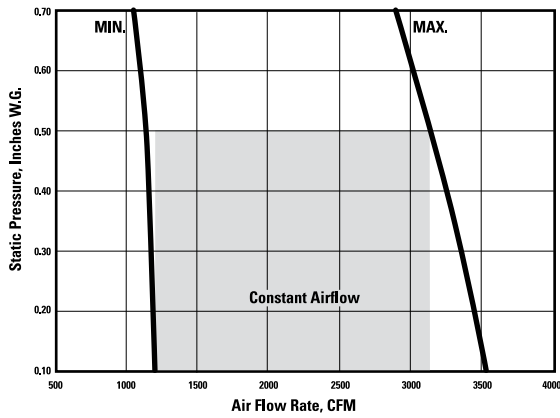

Unit Size 70 - 1 Row Coil

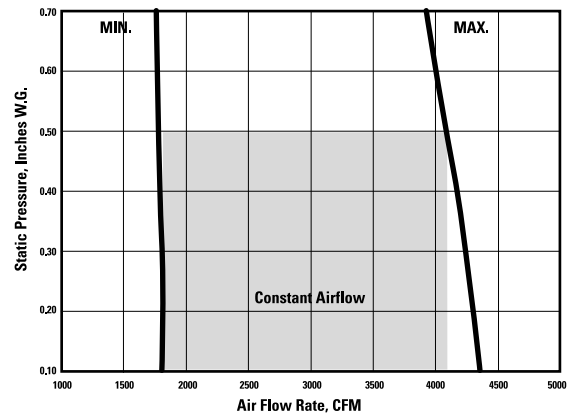

Unit Size 60 - 2 Row Coil

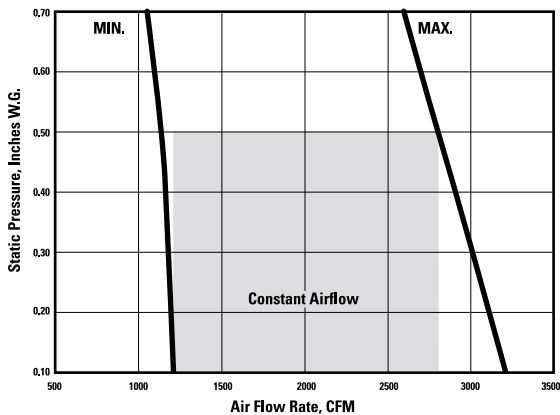

Unit Size 70 - 2 Row Coil

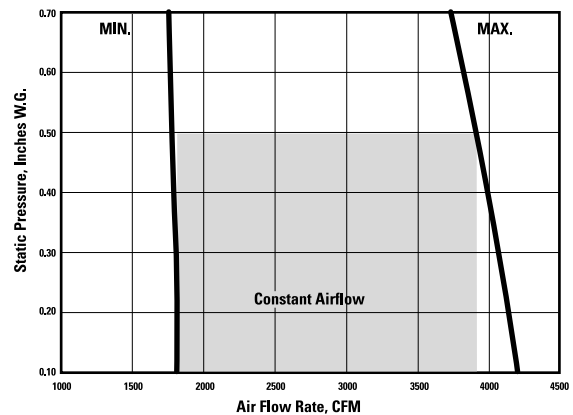

Caution to Contractors

Fan powered terminal units are not intended for use as temporary heat or ventilation during building construction. The terminal units are not designed nor equipped to operate in a dusty construction environment. Recirculating fan wheels can become coated with construction dust, resulting in an unbalanced wheel. This in turn can contribute to reduced motor life. Inlet air filters would provide little protection as they would quickly become plugged with construction dust.

A fan powered terminal unit should never be operated if the downstream ductwork has not been installed. A minimum of 0.1" W.G. downstream static pressure resistance is required for safe operation of the fan motor. For units with electric heaters a minimum of 0.2" W.G. is required.

Please Note: Price cannot warrant against unauthorized operation under conditions as outlined on this page.

Electronic Airflow Adjustment Procedure

In order to correct for poor inlet conditions (which cause inaccurate airflow sensing) or changing design parameters, it may be necessary to adjust the factory set minimum and maximum air flow rates of a fan powered terminal in the field. These adjustments are performed at the wall mounted thermostat. In the event that inlet conditions to the terminal are causing the inaccuracies, the calibration curves referred to in the procedures will no longer be valid. In this case, either a duct traverse or air outlet measurement will be required to establish true air volumes.

Calibration Procedure for Velocity Adjustments made at Thermostat

A. Required Tools:

1. Small flat blade (1/8") screwdriver.
2. Digital Voltmeter capable of displaying a 0 to 10 VDC range which will display in .01 VDC increments.
3. Test Leads (#HSO-5001).

B. Remove Thermostat Cover

Thermostat Cover is removed by releasing the mounting screws on either side of the cover.

CTE-5101 Cooling Thermostat

1. Be certain the ambient room temperature at the thermostat is within the range of the thermostat (55°F to 85°F) (13°C to 29°C).
2. Connect Digital Voltmeter to the meter taps (1) (fig. 1) on the face of the room thermostat using test leads (see fig. 2).
3. Adjust the cooling set point slider (2) all the way to the right for minimum cooling.
4. Read the DC voltage across the meter taps on the cooling (right) side. Adjust the minimum setpoint (MIN INCR) Potentiometer (3) (clockwise to increase or counter-clockwise to decrease) to the desired DC voltage. The DC voltage may be determined from the calibration curves or by direct air flow measurement.
Note: The minimum setpoint must be adjusted first. Adjustment of the MIN INCR Potentiometer directly affects the maximum setpoint.
5. Adjust the cooling set point slider all the way to the left for maximum cooling.
6. Read the DC voltage across the meter taps on the cooling (right) side. Adjust the maximum setpoint (MAX INCR) Potentiometer (4) (clockwise to increase or counter-clockwise to decrease) to the DC voltage equal to the desired flow (CFM). The DC voltage may be determined from the calibration curves or by direct air flow measurement.
Note: The maximum setpoint must be adjusted last. Adjustment of the MIN INCR Potentiometer directly affects the maximum setpoint.
7. Return the cooling setpoint slider to the desired setpoint. Insert setpoint slider stops if required. Replace the thermostat cover.

Fig. 1 CTE - 5101

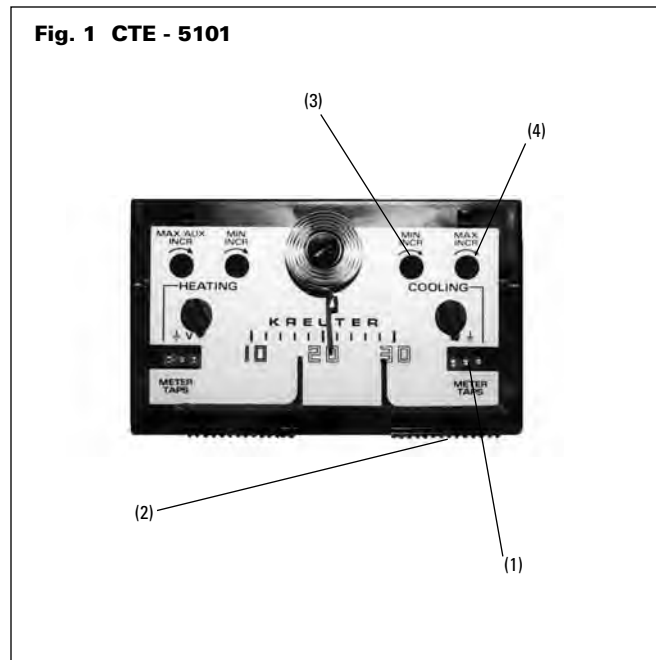
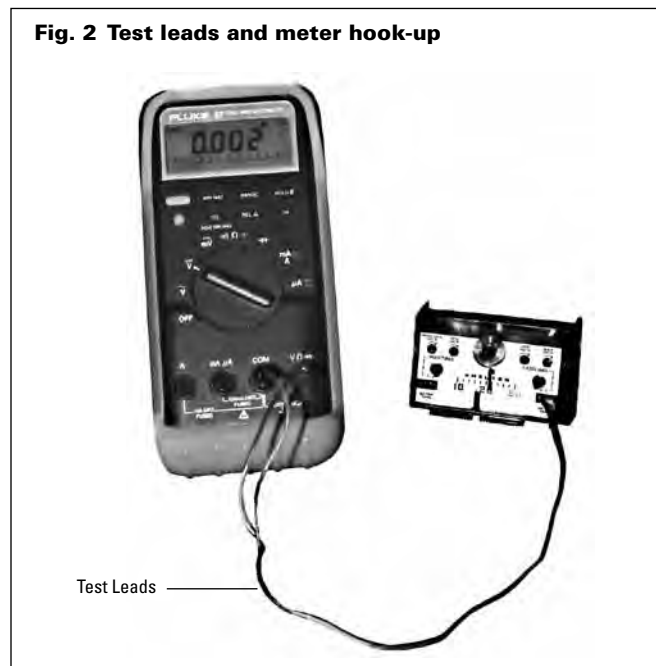
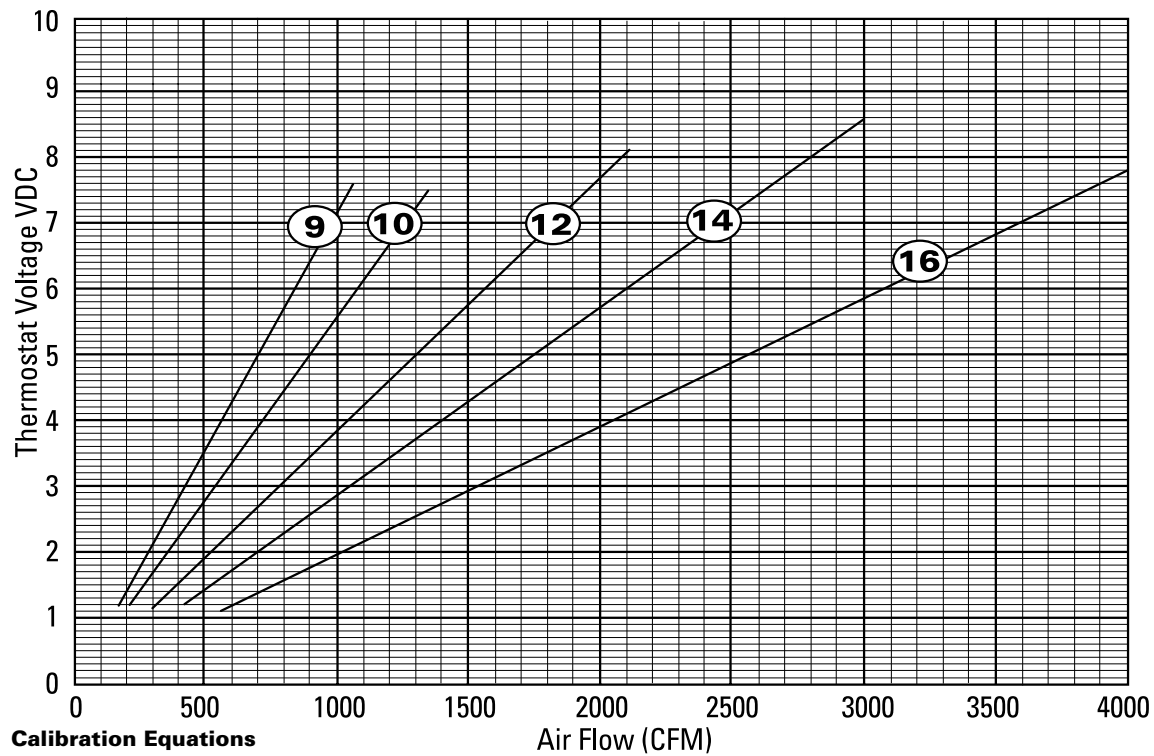
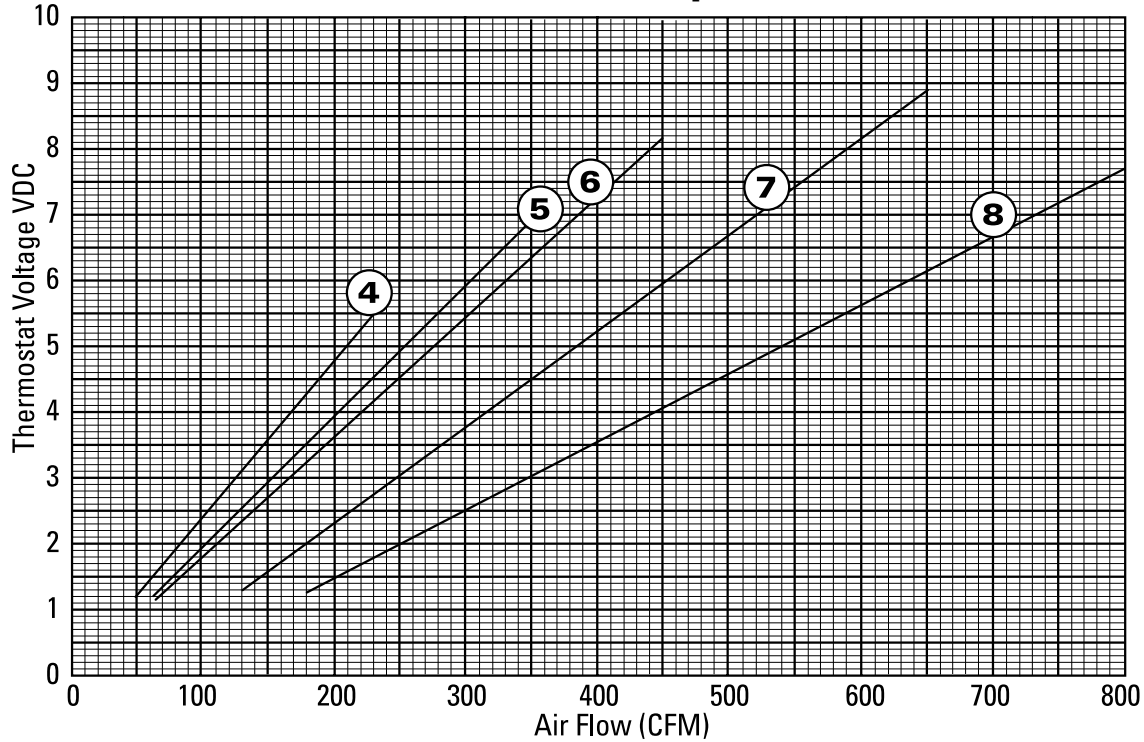

Fig. 2 Test leads and meter hook-up



Electronic Calibration Curves and Equations



Calibration Equations

Size	Equation	Size	Equation
4	VDC = CFM / 40.4	9	VDC = CFM / 138.5
5	VDC = CFM / 50.3	10	VDC = CFM / 181.0
6	VDC = CFM / 54.8	12	VDC = CFM / 259.0
7	VDC = CFM / 72.9	14	VDC = CFM / 354.0
8	VDC = CFM / 103.7	16	VDC = CFM / 515.0

Pneumatic Calibration Procedures

CP100 / CP200

General

1. Remove the protective metal cover.
2. Aligned markings on the face and dials of the controller indicate that the factory settings are intact.
3. Remove the caps from the tees in the HI (red) and LO (green) tubes leading from the air flow sensor in the assembly inlet. Connect a differential pressure gauge to the tees. A gauge with a 0 to 1 inch w.g. scale is recommended.
4. Refer to the calibration curve for the size assembly being serviced. From the curve on page 13, read the differential pressure across the sensor for the required air flow.
5. Alternately, calculate the differential pressure from the equations on page 13.

CP100 (If Supplied)

1. Adjust the minimum (LO) air flow limit first.
2. Set the thermostat signal to 0 psi, or disconnect the thermostat tube to the controller.
3. Turn the minimum (LO) dial on the controller (center knob) until the gauge reads the required differential pressure. Turn the dial slowly, allowing time for the damper actuator to complete its travel in response to the adjustments. (Verify the minimum setpoint by cycling the thermostat pressures).
4. Apply 15 psi minimum air pressure to the thermostat connection at the controller.
5. Turn the maximum (HI) dial on the controller (outer knob) until the gauge reads the required differential pressure. Turn the dial slowly, allowing time for the damper actuator to complete its travel in response to the adjustments. (Verify the maximum setpoint by cycling the thermostat pressure).

CP200 (If Supplied)

1. Adjust the minimum (HI) air flow limit first.
2. Set the thermostat signal to 0 psi, or disconnect the thermostat tube to the controller.
3. Turn the minimum (HI) dial on the controller (center knob) until the gauge reads the required differential pressure. Turn the dial slowly, allowing time for the damper actuator to complete its travel in response to the adjustments. (Verify the minimum setpoint by cycling the thermostat pressure).
4. Adjust the minimum (LO) air flow limit.
5. Apply 15 psi minimum air pressure to the thermostat connection at the controller.
6. Turn the minimum (LO) dial on the controller (outer knob) until the gauge reads the required differential pressure. Turn the dial slowly, allowing time for the damper actuator to complete its travel in response to the adjustments. (Verify the maximum setpoint by cycling the thermostat pressure).

CP101

General

1. Reconnect the thermostat tube to the controller if it has been removed during the calibration procedure.
2. Disconnect the gauge and replace the caps on the tees.
3. Replace the protective cover.

CP101 (If Supplied)

A. Damper Action

1. Damper action is factory set. To reset action, loosen damper selection switch screw and align desired action with the damper position. Retighten screw.
2. Actuator must be repositioned to provide appropriate fail safe position.

B. Reset Start Point

1. Reset start point is factory calibrated to the specified setting on the control assembly label.
2. To field adjust, remove the gauge tap cap at "G" and attach a 0 - 30 psi pressure gauge.
3. Adjust the thermostat pressure at "T" port to the desired start point value with a gradual switch or pressure regulator. (Start point is lowest span pressure).
4. Adjust reset start knob until the gauge pressure begins to increase slightly (greater than zero but less than 0.3).
5. Replace gauge tap cap.

C. Reset Span

1. Reset span is factory calibrated to the specified setting on the control assembly label.
2. To field adjust, remove the gauge tap cap at "G" and attach a 0 - 30 psi pressure gauge.
3. Adjust the thermostat pressure at "T" port to above 15 psi.
4. Adjust reset span knob until the gauge pressure is equal to the desired reset span (total span pressure, not end span pressure).
5. Replace gauge tap cap.

D. Air Volume Limits

1. Remove the caps from the tees in the HI (red) and LO (green) tubes leading from the air flow sensor in the assembly inlet. Connect a differential pressure gauge to the tees. A gauge with a 0 to 1 inch w.g. scale is recommended.
2. Refer to the calibration curve for the size assembly being serviced. From the curve read the differential pressure across the sensor for the required air flow.
3. Alternately, calculate the differential pressure from the equations on page 13.

Pneumatic Calibration Procedures (continued)

Direct Acting Cooling or Reverse Acting Heating

1. Adjust the minimum air flow limit first.
2. Set the thermostat signal to 0 psi or disconnect the thermostat tube from the controller.
3. Adjust the "LO STAT" dial on the controller (center knob) until the gauge reads the required differential pressure for minimum air volume. Turn the dial slowly, allowing time for the damper actuator to complete its travel in response to the adjustments.
4. Adjust the maximum air flow limit, after verifying the minimum air flow limit is set correctly.
5. Apply 15 psi minimum air pressure to the thermostat connection at the controller.
6. Adjust the "HI STAT" dial on the controller (outer knob) until the gauge reads the required differential pressure for maximum air volume. Turn the dial slowly, allowing time for the damper actuator to complete its travel in response to the adjustments.
7. Cycle the thermostat several times. This can be quickly accomplished by removing the cap from the gauge tap (Port G) and varying the bleed rate with finger pressure. Replace cap and check the air flow limits. If setpoints have changed, repeat steps 1 to 7.

Reverse Acting Cooling or

Direct Acting Heating

1. Adjust the maximum air flow limit first.
2. Set the thermostat signal to 0 psi or disconnect the thermostat tube from the controller.
3. Adjust the "LO STAT" dial on the controller (center knob) until the gauge reads the required differential pressure for maximum air volume. Turn the dial slowly, allowing time for the damper actuator to complete its travel in response to the adjustments.
4. Adjust the minimum air flow limit, after verifying the maximum air flow limit is set correctly.
5. Apply 15 psi minimum air pressure to the thermostat connection at the controller.
6. Adjust the "HI STAT" dial on the controller (outer knob) until the gauge reads the required differential pressure for minimum air volume. Turn the dial slowly, allowing time for the damper actuator to complete its travel in response to the adjustment.
7. Cycle the thermostat several times. This can be quickly accomplished by removing the cap from the gauge tap (Port G) and varying the bleed rate with finger pressure. Replace cap and check the air flow limits. If setpoints have changed, repeat steps 1 to 7.

General

1. Always adjust the "LO STAT" dial first.
2. After calibration is complete, reconnect the thermostat tube to the controller if it has been removed during the calibration procedure.
3. Disconnect the gauge and replace the caps on the tees.
4. Replace the protective metal cover.

Digital Calibration Procedures

In order to set/monitor different functions of the PCDT you must navigate through menus via the digital thermostat. Through these menus many settings can be monitored and adjusted.

To enter the SERVICE menu:

1. Ensure PCDT is powered.
2. On the PCDT press and hold down the Down arrow ▼ on the thermostat, then press and hold down the Up ▲ arrow at the same time.
3. After approximately 5 seconds the PCDT will enter PIN (password) mode.
4. Enter the PIN, down, up, up, down.
5. You are now in the service menu.*

The following features can be accessed from this service mode:

1. Balance
 - View and adjust air flow settings.
 - Force to min/max air flow settings.
 - Force the damper position.
2. Manual mode
 - Force damper positions.
 - Manipulate reheat outputs.
 - Fan control.
3. Calibration menus
 - Room sensors offset.
 - Supply A.T. sensor offset.
4. Address
 - Set controller BACnet address.
 - Adjust BACnet settings.

* The PCDT will exit the service menu after approximately 20 minutes.

* See the PCDT service and installation for further instructions.

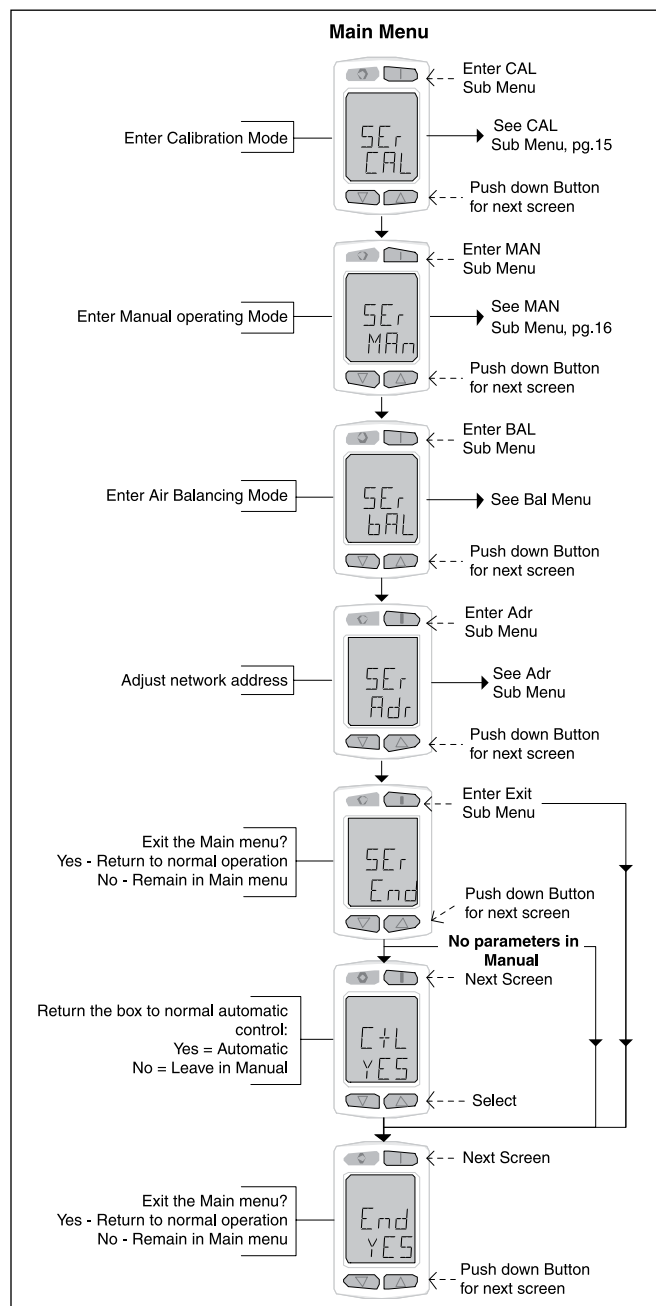
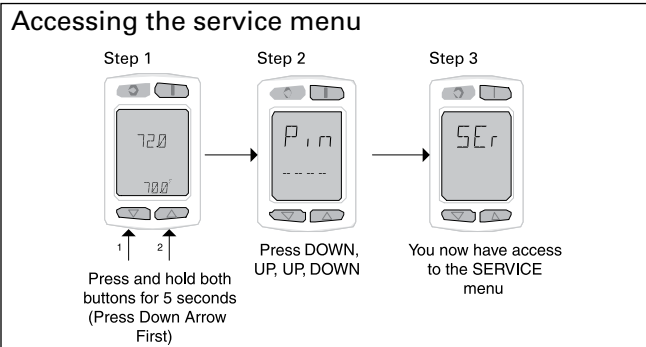

Pneumatic and Digital Calibration Curves

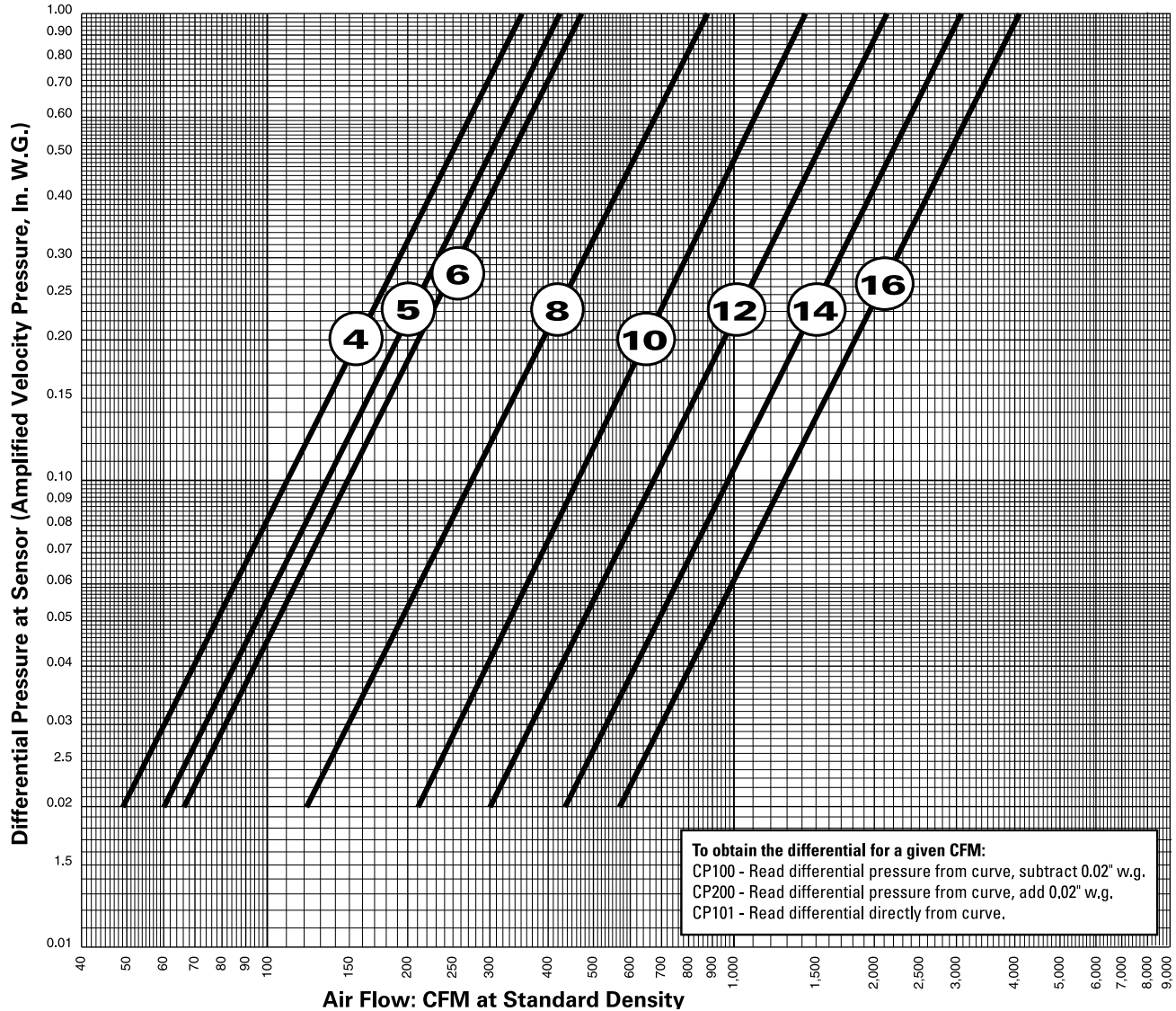

Calibration Equation

$$VP = \left(\frac{Q}{K}\right)^2$$

- VP** - differential pressure at sensor, inches w.g.
Q - air flow rate, cfm at standard density.
K - calibration constant

Unit Size	K
6	468
8	890
10	1487
12	2141
14	3045
16	4074

NOTES

1. Gauge taps are normally supplied with the pneumatic controls to allow field measurement of the differential pressure at the sensor with a manometer, magnahelic or other measuring device.

If the terminal velocity controls utilize a flow-through transducer, a proper velocity pressure reading will NOT be read at the gauge taps and the calibration curves CANNOT be used for field measurement. The flow-through transducer operates on the principle of mass flow rather than pressure differential.

Controls utilizing a dead-ended pressure transducer will allow field measurement with the gauge taps and calibration curves provided.

2. Setting flow limits for a differential pressure of less than 0.02 inches is NOT recommended. Stability and accuracy of flow limits may not be acceptable due to low velocity pressure signal. Performance will vary depending on the terminal unit controls provided.
3. For field calibration of air flow limits refer to the control contractor's documentation.

Troubleshooting Guide

<p>General</p>	<ol style="list-style-type: none"> 1. Confirm fan box size and rating with blueprint and box schedule (check Control Assembly label on terminal unit). 2. Visually check pneumatic and electrical connections with the Control and Wiring diagram(s) located inside the electrical enclosure or in the applicable controls brochure. 3. Verify that the supply voltage is the same as specified on the control diagram(s) or Voltage Information label. 4. Confirm main air pressure (15 psi min., 25 psi max.)
<p>Noise</p>	<ol style="list-style-type: none"> 1. Foreign material in fan. 2. Relay chatter. 3. Fan or duct size selection too small for application causing high air velocity. 4. Vibrating duct work. 5. Unbalanced fan wheel causing it to hit the housing. 6. Defective or worn out bearing in motor.
<p>Primary Air Volume not as Specified</p>	<ol style="list-style-type: none"> 1. Check controller operation, adjust if necessary. 2. Check for proper control signal from thermostat. Cycle thermostat and monitor. 3. Check operation of damper actuator and linkage. 4. Confirm sufficient inlet duct static pressure is available at the terminal unit. 5. Recommend a minimum of 3 duct diameters of straight inlet duct, either sheet metal or flexible. It is to be the same size as the inlet, between the unit inlet and any transition, take-offs or fittings. Poor inlet conditions may necessitate controller re-calibration. 6. Check the flow sensor for blockage.
<p>Air Volume Not As Specified</p>	<ol style="list-style-type: none"> 1. Check filter for excessive dust build-up. 2. Check fan for particle blockage. 3. Check coils for particle blockage. 4. Measure downstream static pressure, it must be no less than 0.20 inches W.G. in order to keep the fan from overheating. 5. Verify that the supply voltage is the same as specified on the wiring diagram. See wiring diagram pasted on the inside of the electrical enclosure or in the applicable controls brochure. 6. Insulating duct liner loose. 7. Unit was not air balanced. See Air Balancing Procedure on page 7. 8. Leaks in duct work. 9. Obstruction in duct work. 10. Sharp elbows near fan outlet. 11. Improperly designed turning vanes.
<p>Fan Does Not Operate</p>	<ol style="list-style-type: none"> 1. Check the unit wiring against the provided Control and Wiring diagrams. See inside cover of the electrical enclosure for diagrams. 2. Verify that the disconnect switch or breaker is not opened. 3. Check for proper control signal from thermostat. Set thermostat for full heating and monitor output. 4. If fan cycles on and off, check the downstream static pressure. It must be no less than 0.20 inches W.G. in order to keep the fan from overheating. 5. Fan wheel may be touching the housing.

Replacement Parts

Component	Part#	Description
PSC Fan Motors	019 150-001	115V - 1/8 HP (Size 20)
	019 152-001	115V - 1/4 HP (Size 30)
	019 154-003	115V - 1/2 HP (Size 40 & 60)
	019 156-002	115V - 3/4 HP (Size 50 & 70)
	019 588-001	208-240V 1/8 HP (Size 20)
	019 589-001	208-240V - 1/4 HP (Size 30)
	019 590-001	208-240V - 1/2 HP (Size 40 & 60)
	019 591-001	208-240V - 3/4 HP (Size 50 & 70)
	019 592-001	208-240V - 1 HP (Size 60)
	019 151-001	277V - 1/8 HP (Size 20)
	019 153-001	277V - 1/4 HP (Size 30)
	019 155-003	277V - 1/2 HP (Size 40 & 60)
	019 157-003	277V - 3/4 HP (Size 50 & 70)
	019 167-001	277V - 1 HP (Size 60)
PSC Fan Speed Speed Controllers	233 563-100	8A / 115V (Size 20, 30)
	233 563-400	15A / 115V (Size 40, 50, 60, 70)
	233 563-200	8A / 208/240/277V (Size 20-70)
	233 563-500	10A / 240/277V (Size 60)
ECM Motors	019173-001	115/240V - 1/3 HP (Size 10, 20)
	019173-002	277V - 1/3HP (Size 10, 20)
	019 171-001	115/240V - 1/2 HP (Size 20, 30, 40, 60)
	019 174-001	115/240V - 3/4 HP (Size 50, 70)
	019 171-002	277V - 1/2 HP (Size 20, 30, 40)
019 174-002	277V - 3/4HP (Size 50, 70)	
ECM Speed Controller	232 953-100	ECM Electronic Fan Speed Controller
Capacitors	019 874-001	5 mfd
	019 874-006	7.5 mfd
	019 874-002	10 mfd
	019 874-003	15 mfd
	019 874-007	20 mfd
Blowers	100 185-001	Size 10
	100 186-001	Size 20
	100 186-002	Size 30
	100 091-001 + 100 092-001	Size 40, 60
	100 091-001 + 100 186-003	Size 50, 70
Controllers	019 815-001	Electronic CSP-5001 Controller / Actuator
	076 730-002	Pneumatic CP100 Controller
	076 824-001	Pneumatic CP200 Controller
	076 823-001	Pneumatic CP101 Controller
Actuators	019 915-001	Electric MEP-5001 24V Floating
	019 096-001	Electric ML6161B 24V Floating
	076 857-001	Pneumatic MCP-8031 Actuator
Thermostats	076 863-001	Electronic Cooling (CTE-5101)
	019 723-001	Electronic Heating-Cooling (CTE-5103)
	019 726-001	Electronic Cooling w/Reheat (CTE-5104)
	019 727-001	Electronic Heating-Cooling (CTE-5105)
Control Components	076 813-001	Pressure Diverting Relay
	076 811-001	Lo Pressure Selector
	076 817-001	Hi Pressure Selector
	019 873-001	P-E Switch
	019 436-004	115/24V - 20VA Transformer
	019 436-001	115/24V - 50VA Transformer
019 436-005	277/24V - 50VA Transformer	
Replacement Latch	027370-001	Ludwig snap latch



PRICE
INDUSTRIES

2975 Shawnee Ridge Court
Suwanee, Georgia USA 30024
Ph: 770.623.8050 Fax: 770.623.6404



PRICE
INDUSTRIES

1290 Barrow Industrial Parkway
Auburn, Georgia USA 30011



PRICE
INDUSTRIES

999 North Thornton Road
Casa Grande, Arizona USA 85222-3809



e.h. price
LIMITED

638 Raleigh Street
Winnipeg, Manitoba Canada R2K 3Z9
Ph: 204.669.4220 Fax: 204.663.2715

The founding principles of our company have never changed - business integrity, first class service and a commitment to people. Price manufacturing endeavors arose from our belief that we could supply superior products and services at a reasonable price. Our mission is to become the world-wide supplier of preference for air distribution products and services. You can rely on Price – our products and services – with confidence.

Warranty: The Company warrants and guarantees that all goods within this catalog that have been manufactured by the Company have been manufactured in accordance with the specifications published herein and will be free from defects in material and workmanship for a period of twelve (12) months from the date of Bill of Lading issued by the Company. The Company will replace defective product at its option, but will not be responsible for labor or material charges in replacing product or consequential damages. Any installation not conforming with the Company's specifications, manuals, bulletins or instructions or any misuse or any modification not authorized by the Company voids this warranty. This warranty is in lieu of all Provincial, State, and Federal statutory warranties and the conditions herein are in substitution and replacement of such warranties, statutory or otherwise.

Your Local Price Representative:

Grilles & Diffusers

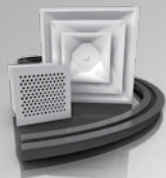

Critical Environments

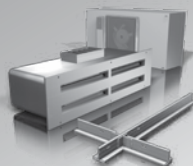

Terminals

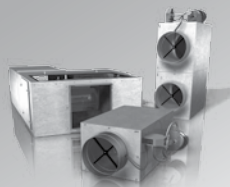

Sustainable Building



Noise Control

