

# LFH

LINEAR FLOOR HEATER



# LFH

## Linear Floor Heater

---

The Linear Floor Heater (LFH) is a premium linear floor terminal with integrated heat, designed for raised floor applications and ideal for perimeter ventilation. Using the LFH allows for conditioning of the perimeter zone without the use of an underfloor fan terminal.

The LFH incorporates a heater for perimeter heating in a compact, drop in steel plenum to enclose all components. In addition to having various grille style options, ordered separately, these terminal units can be configured in either a discrete or continuous grille application.

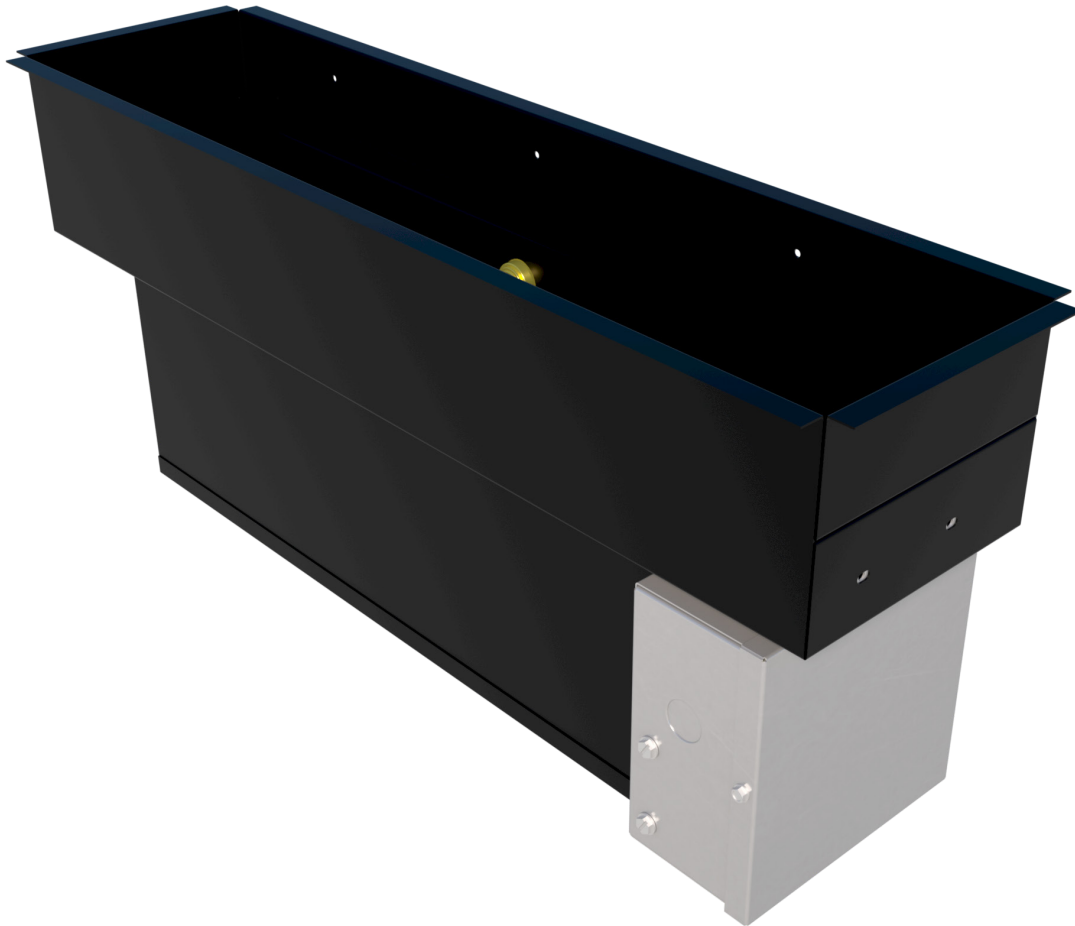

## DESIGNED TO MAXIMIZE MODULARITY

- + The LFH heater is an integral component of the ModuFlex System. See Perimeter Zone PZ1 and Special Zone SZ2 in the ModuFlex overview at the beginning of the Underfloor section for example applications and control solutions.
- + The drop-in plenum design and plug-and-play wiring allow for increased flexibility and ease of installation.
- + Power and control signals delivered to each unit via a single daisy chained cable, with up to six units in series.

## PERFORMANCE AND COMFORT TESTED

- + The LFH assembly is rigorously tested and validated in an underfloor application.
- + The LFH series is tested in accordance with ASHRAE 70-2006.
- + Control enclosure and electric heater are ETL certified.

## VARIOUS STYLES

- + Hot water and electric coils available.

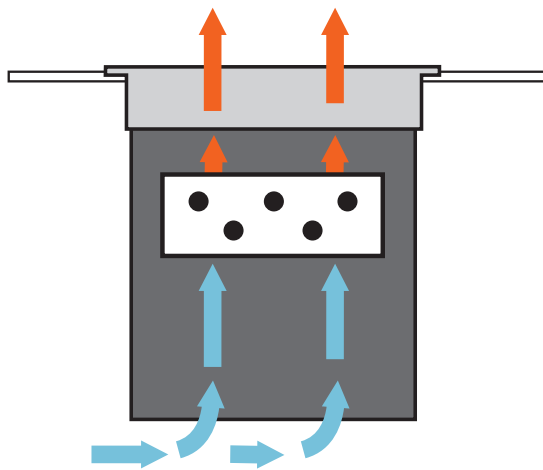

*LFH Airflow Pattern*

## TYPICAL APPLICATIONS

The LFH is especially suited to corridors and large windows where higher airflows and heating capacities are required. The LFH is recessed into the raised floor plenum, and is designed to handle regular foot traffic. This makes them well suited for offices, lobbies, schools and universities with raised floor or trench systems along the perimeter. Due to its modular nature and ability to work with other VAV floor devices with Price controllers, the LFH is also commonly used in conference rooms and offices where supplemental heat is necessary.

## FEATURES

- + 24 VAC floating-point actuator for damper control
- + Plug-and-play connection with native BACnet Price UMC3 controllers
- + Plenum rated Cflex purple cable provided for simple connection to the Price underfloor system
- + Drop in installation from room side

## CONNECTING MULTIPLE UNITS

Multiple LFH units can be piped in a series or parallel configuration to meet room design requirements.

The series configuration is a cost savings arrangement as all the fluid flow is controlled by a single hot water valve hence minimizing the control equipment.

The parallel piping configuration provides tighter control and potentially higher capacity as there is less of a loss in capacity from one LFH to the next.

### Series Connection

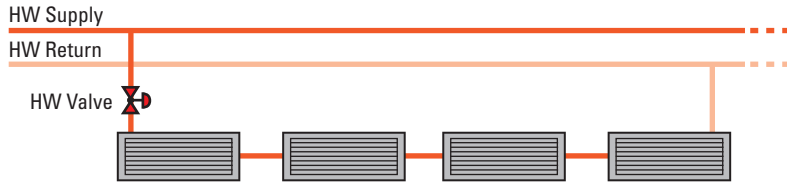

### Parallel Connection

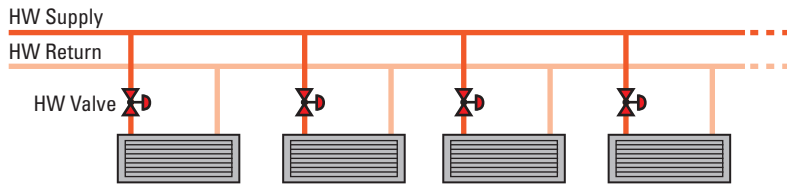

Control Sequence

## Controls Details

One PCM can control up to 12 LFH linear floor heaters. Each PCM controls a single zone in which all dampers and heaters will operate in synchronization. Each linear floor heater is supplied with a plenum rated, stranded quick-connect cable that allows all units to be plug-and-play daisy chained to each other and plug-and-play connected to the PCM.

When the linear floor heaters are in cooling mode, the dampers will modulate between min and max plenum air flow to allow cool air into the space. When the linear floor heaters are in heating mode, either the electric heater is turned on or the hot water valve modulates between min and max flow.

In heating mode, the LFH damper is modulated between min and max heating flows.

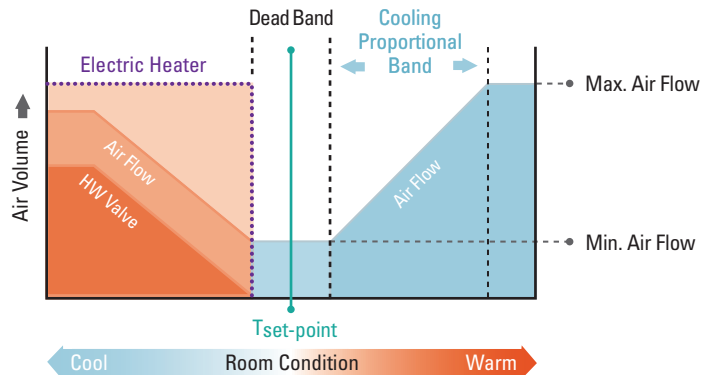

LFH Room Temperature Condition

# DIMENSIONAL DATA

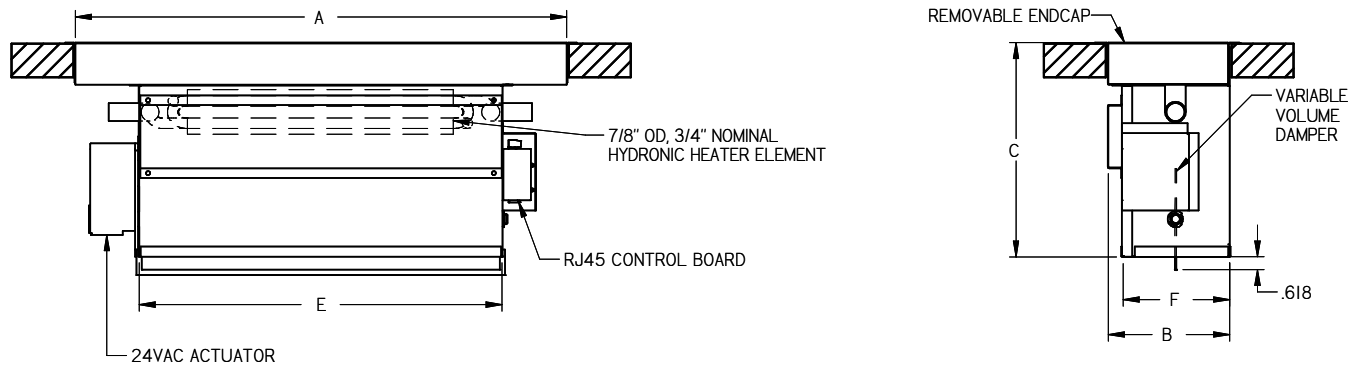

NOM. SIZE	NOM. LFG SIZE	UNIT OVERALL			PLENUM INLET		ROUGH OPENING	AIRFLOW (CFM)
		A	B	C	E	F		
24 X 6	23 3/4 X 5 3/4	23 7/8	5 7/8	10 3/8	17 1/2	5 1/8	24 X 6	100 - 200
48 X 6	47 3/4 X 5 3/4	47 7/8	5 7/8	10 3/8	41 1/2	5 1/8	48 X 6	300 - 500

# PERFORMANCE DATA

		Static Pressure, in.w.g.	0.05	0.08	0.10
		Air Flow Rate, cfm	111	152	171
Unit Type	Water Flow Rate, gpm	Heating Capacity, MBH			
LFH	0.25	4.33	4.91	5.36	
24"x6"	1.00	5.12	5.94	6.35	
180 °F EWT	2.00	5.68	6.69	7.08	
68 °F EAT	4.00	5.97	7.09	8.35	
LFH	0.25	2.74	3	3.15	
24"x6"	1.00	3.33	3.77	4	
140 °F EWT	2.00	3.73	4.29	4.6	
68 °F EAT	4.00	3.92	4.57	4.93	
LFH	0.25	1.66	1.76	1.82	
24"x6"	1.00	1.87	2.19	2.33	
110 °F EWT	2.00	2.16	2.47	2.62	
68 °F EAT	4.00	2.31	2.65	2.83	
LFH	0.25	4.64	4.9	5.59	
24"x6"	1.00	5.35	6.15	6.49	
180 °F EWT	2.00	5.97	6.75	7.36	
65 °F EAT	4.00	6.32	7.36	7.74	
LFH	0.25	2.94	3.24	3.28	
24"x6"	1.00	3.48	3.94	4.46	
140 °F EWT	2.00	3.92	4.48	4.8	
65 °F EAT	4.00	4.14	4.85	5.13	
LFH	0.25	1.66	1.86	1.99	
24"x6"	1.00	2.06	2.3	2.46	
110 °F EWT	2.00	2.29	2.69	2.83	
65 °F EAT	4.00	2.46	2.97	3.05	

		Static Pressure, in.w.g.	0.05	0.08	0.10
		Air Flow Rate, cfm	320	412	468
Unit Type	Water Flow Rate, gpm	Heating Capacity, MBH			
LFH	0.25	5.85	6.69	6.19	
48"x6"	1.00	7.62	8.50	8.59	
180 °F EWT	2.00	9.16	10.06	10.43	
68 °F EAT	4.00	10.06	11.15	11.57	
LFH	0.25	3.45	3.88	3.96	
48"x6"	1.00	4.79	5.31	5.41	
140 °F EWT	2.00	5.83	6.37	6.54	
68 °F EAT	4.00	6.48	7.11	7.36	
LFH	0.25	2.04	1.88	2.09	
48"x6"	1.00	2.76	2.96	3.03	
110 °F EWT	2.00	3.32	3.63	3.73	
68 °F EAT	4.00	3.74	4.08	4.29	
LFH	0.25	5.80	6.60	6.38	
48"x6"	1.00	8.00	8.67	8.85	
180 °F EWT	2.00	9.38	10.27	10.64	
65 °F EAT	4.00	10.23	11.39	11.80	
LFH	0.25	4.00	3.88	3.77	
48"x6"	1.00	5.14	5.49	5.68	
140 °F EWT	2.00	6.06	6.60	6.83	
65 °F EAT	4.00	6.75	7.37	7.69	
LFH	0.25	2.07	2.15	2.48	
48"x6"	1.00	2.98	3.13	3.27	
110 °F EWT	2.00	3.56	3.87	4.01	
65 °F EAT	4.00	4.00	4.40	4.57	

**Performance Notes:**

- All data tested with damper fully open where applicable.
- Units are tested in accordance with ASHRAE Standard 70-2006.
- Static Pressure measured in in. w.g.
- Do not operate LFH in such a way as to cause leaving air temperature to be above 120 °F.
- Calculate air temperature rise (ATR) as follows:  
ATR (°F) = 927 x MBH/cfm.
- Calculate water temperature drop (WTD) as follows:  
WTD (°F) = 2.04 x MBH/gpm.

## Electric Heater Element

- + 24 in. length = 1800 Watt
- + 48 in. length = 3450 Watt

**Note**

Electric heater requires 70 CFM per 1.0 kW

## MODUFLEX

ModuFlex by Price is an Underfloor Air System Solution that is easy to apply. This system combines the benefits of Raised Access Floor (RAF) and Price's years of occupant comfort experience to provide a tailored solution that achieves a comfortable building environment and maximum flexibility. LFH products are most commonly used in perimeter zones.

### Perimeter Zones

These zones are typically more complex than interior zones. Perimeter zones generally have larger and more varying loads and often require auxiliary heat. Using the proper system helps control heating and cooling requirements for the space.

### Trough Heating and Cooling

An efficient mode of conditioning perimeter zones is by placing drop-in plenum heaters within the perimeter grilles to heat and cool. Cooling is handled through variable air dampers in the trough, and heating is used when the thermostat notes a drop in temperature below the set point. This removes the need for ductwork and fan terminals along the perimeter, reducing noise and energy consumption. A thermostat monitors the room temperature, while the PCM adjusts the dampers to meet the space requirements. This minimizes fan energy usage and noise generated by the terminals.

### Forced Heat

Occurs when plenum air is forced across the heater with the plenum damper open. This is typically only required when high heating capacities are demanded.

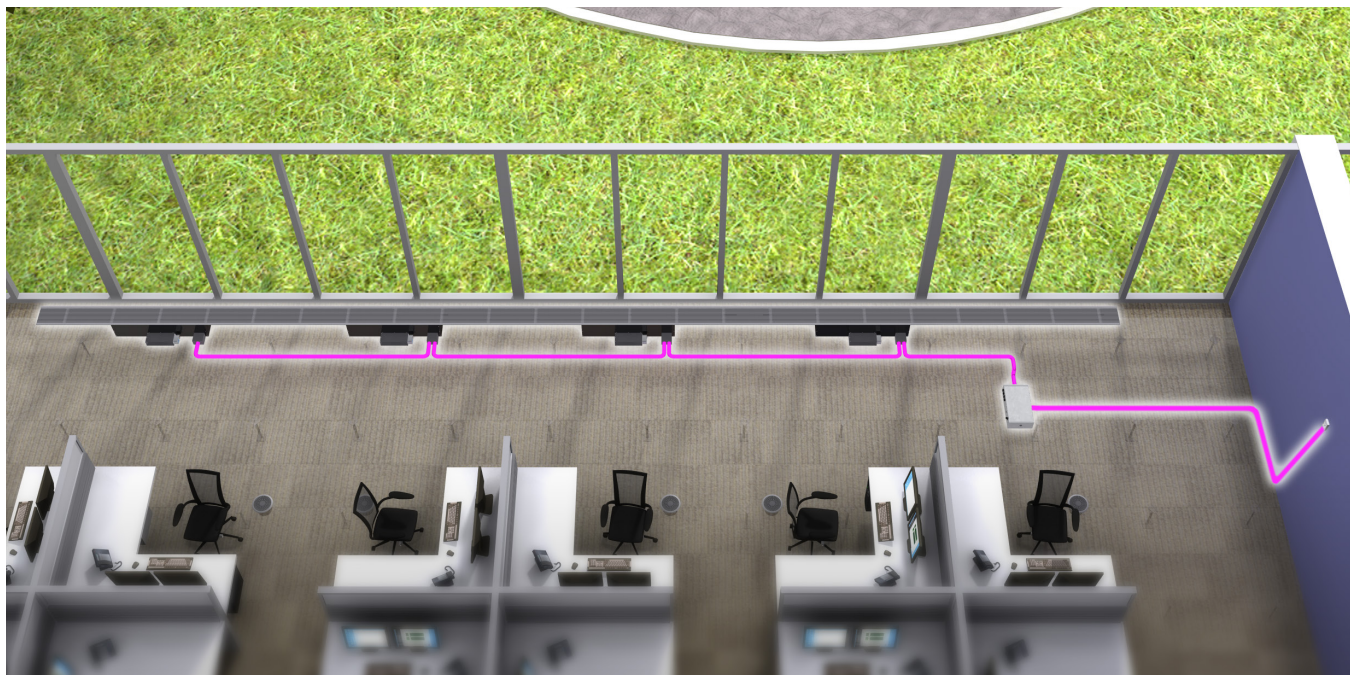



Product Improvement is a continuing endeavour at Price. Therefore, specifications are subject to change without notice. Consult your Price Sales Representative for current specifications or more detailed information. Not all products may be available in all geographic areas. All goods described in this document are warranted as described in the Limited Warranty shown at [priceindustries.com](http://priceindustries.com). The complete Price product catalog can be viewed online at [priceindustries.com](http://priceindustries.com).