



# High Performance Schools

Combining Price's years of occupant comfort experience and sustainable HVAC technologies to deliver high performance schools with improved learning environments, reduced operating costs, lower maintenance and reduced energy use.

# High Performance Schools (HPS)

The United States Environmental Protection Agency (EPA) defines a high performance school as **energy and resource efficient**. Creating a high performance school is not difficult, but it requires an integrated, “whole building” approach from the beginning of the design process.

Even a modest investment in school building performance can yield significant benefits and cost savings, such as:

- **Improving health and comfort to enhance student learning**
- **Increasing average daily attendance**
- **Reducing utility bills**
- **Taking advantage of incentive programs**

A variety of air distribution technologies exist in the market today that have achieved significant improvements for school systems throughout North America to help meet the modern demands of operating educational facilities.

## CONSIDERATIONS

- Low maintenance
- Low operating costs
- Lower noise levels
- High indoor air quality
- Improved thermal comfort
- Life cycle costs





# Displacement Ventilation

## How does all air displacement work?

Displacement ventilation is an energy efficient method of air delivery that supplies air directly into the occupied portion of the space at low air speeds. Air quality and occupant satisfaction is improved due to the manner in which the air distributes throughout the space.

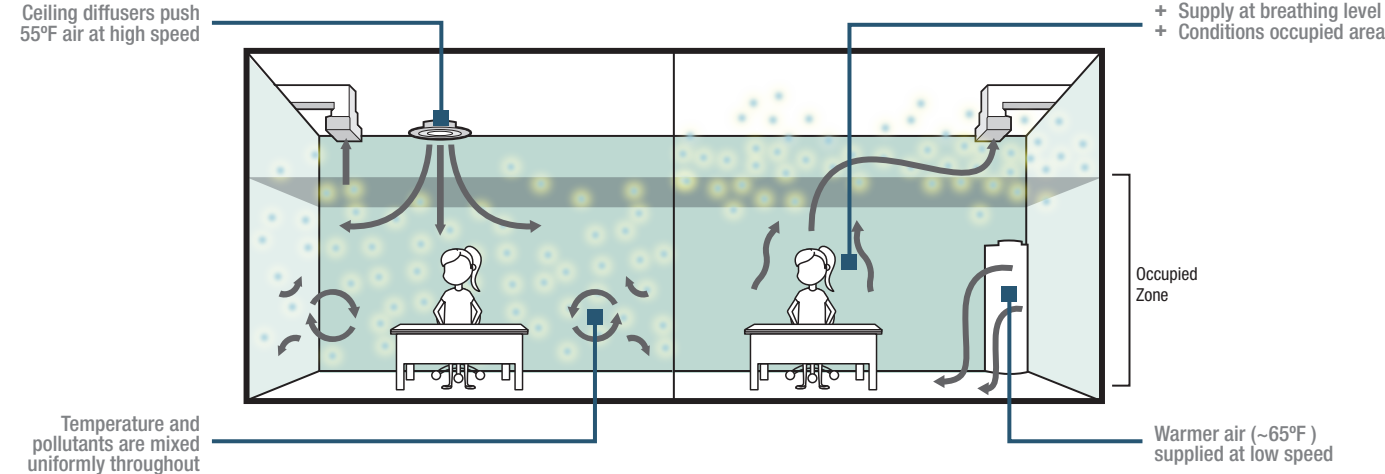

Various well regarded institutions recommend using displacement ventilation.<sup>2,3,4,5</sup>



## Displacement Chilled Beams

There is an increasing need for energy efficient air conditioning systems as energy codes become more stringent. Displacement chilled beams allows engineers to combine the benefits of both chilled beam and displacement technologies.

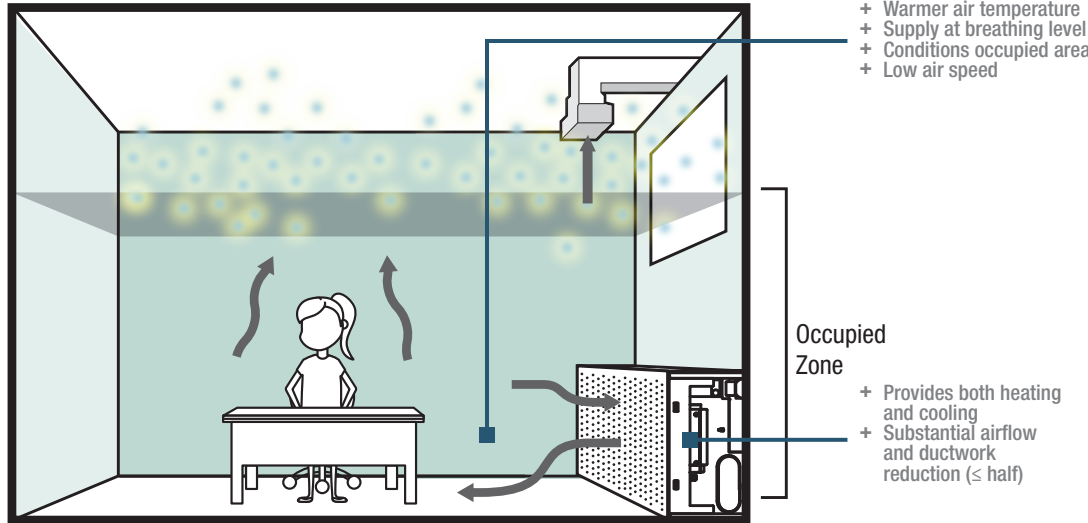

# Low Maintenance

With limited operating budgets, schools can save by installing a displacement system. A recent study found that schools should be spending \$145 billion annually to keep up with facilities, right now they are only spending \$99 billion.<sup>6</sup> When systems aren't cared for they start to break down resulting in more serious issues affecting maintenance costs and air quality.



**CONSIDERATIONS**

- Low maintenance**
- Low operating costs
- Lower noise levels
- High indoor air quality
- Improved thermal comfort
- Life cycle costs

**Maintenance issues leads to poor indoor air quality which can lead to a decrease in student attendance.**

It is more difficult to assure proper maintenance of multiple units over time and they [unit ventilators] present additional opportunities for moisture problems through wall penetrations and from drain pan and discharge problems.<sup>7</sup>

## Some systems require more in-space maintenance

The table below shows an example maintenance schedule for a refrigerant system. This system not only requires monthly maintenance, some of the tasks can only be performed by quality personnel increasing overall maintenance costs.

*Example refrigerant maintenance schedule<sup>8</sup>*

Maintenance Requirements	Task	Monthly	Every 4 months	Once a year	As needed
Increase frequency of task if the area of installation is very dusty	Clean the air filter	×			
	Clean the condensate drain pipe		×		
These operations must always be performed by qualified personnel	Clean the condensate drain pan			×	
	Thoroughly clean the head exchanger			×	
	Replace and remove the control batteries				×

Due to the reduction in moving parts and mechanical equipment (fans, filters, drain pans, and condensate pumps) found in beams and displacement units, these systems typically have lower maintenance costs compared to other systems.

*Zero In-Space Maintenance with Displacement and Chilled Beams*

In-Space Maintenance	Displacement Ventilation & Chilled Beams	Traditional Unitary Systems	Refrigerant Systems
No Filters	✓	×	×
No Drain Pans	✓	×	×
No Wet Coils to Clean	✓	×	×
No Envelope Wall Openings	✓	×	✓
No Refrigerant Line Monitoring	✓	✓	×

Displacement Ventilation systems do not require coil cleaning or filter changes in the classroom space, eliminating maintenance related interruptions and reducing load on the maintenance staff.

*Assistant Director of Facilities, Town of Scituate, MA*

## Low Operating Costs

The nationally recognized ventilation standard, ASHRAE 62.1, allows for a **reduction in outside air volume (up to 33%)** to condition a space due to the improved air quality a displacement system generates.<sup>9</sup> The ability to reduce the amount of outside air required can significantly impact annual energy savings.

### CONSIDERATIONS

- Low maintenance
- Low operating costs**
- Lower noise levels
- High indoor air quality
- Improved thermal comfort
- Life cycle costs

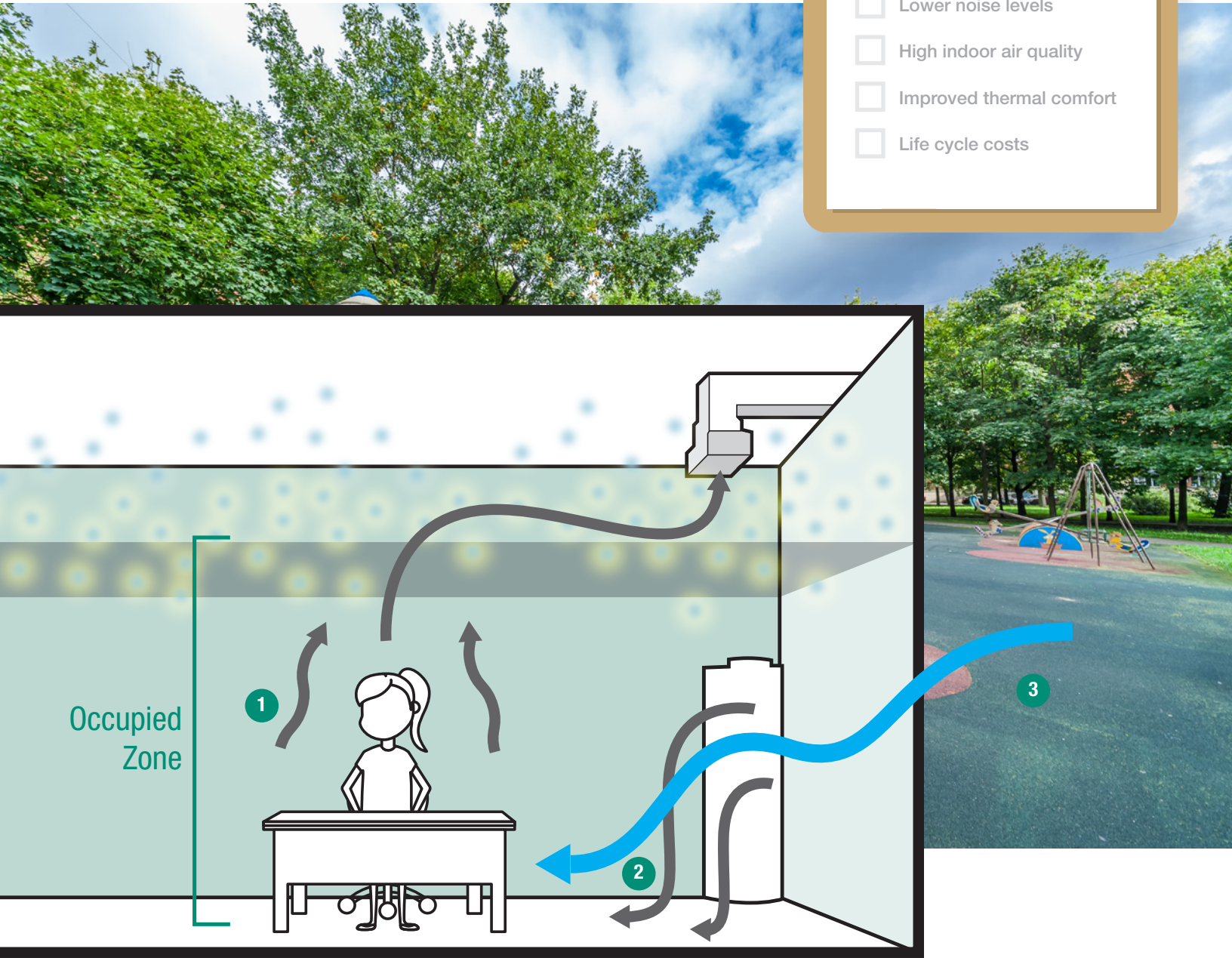

**1. Lower fan power requirement,** because air is driven naturally upwards by occupants.

**2. Warmer supply air temperature** can require **less cooling load on equipment.**

**3. Less expense to cool.** Use outdoor air up to 65°F to cool the space.

## Energy Savings

A displacement requires less fan power equipment, and less cooling load to condition a space resulting in significant annual electrical savings.

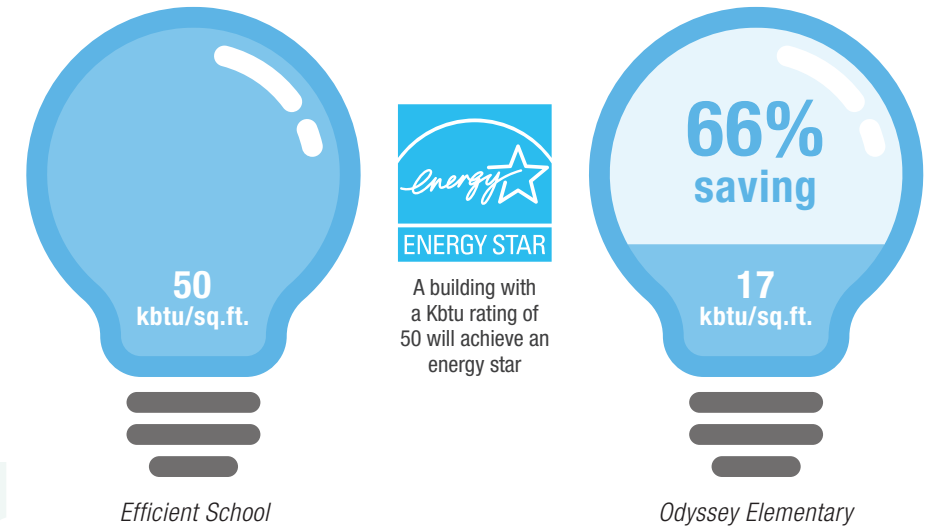

...Thermal displacement was really a **key to unlock** the door to a lot of **energy savings**...Our results here at (Odyssey Elementary, UT) after our first year of operation were 17 kbtu per sq. ft. (66% savings).

*Utah Design Engineer Principal*

## Free Cooling Hours

An all air displacement system can significantly reduce long term operational costs through cooling a space using outdoor air. **Using 100% fresh outdoor air can improve occupant health and performance.**

■ Mixed    ■ Displacement

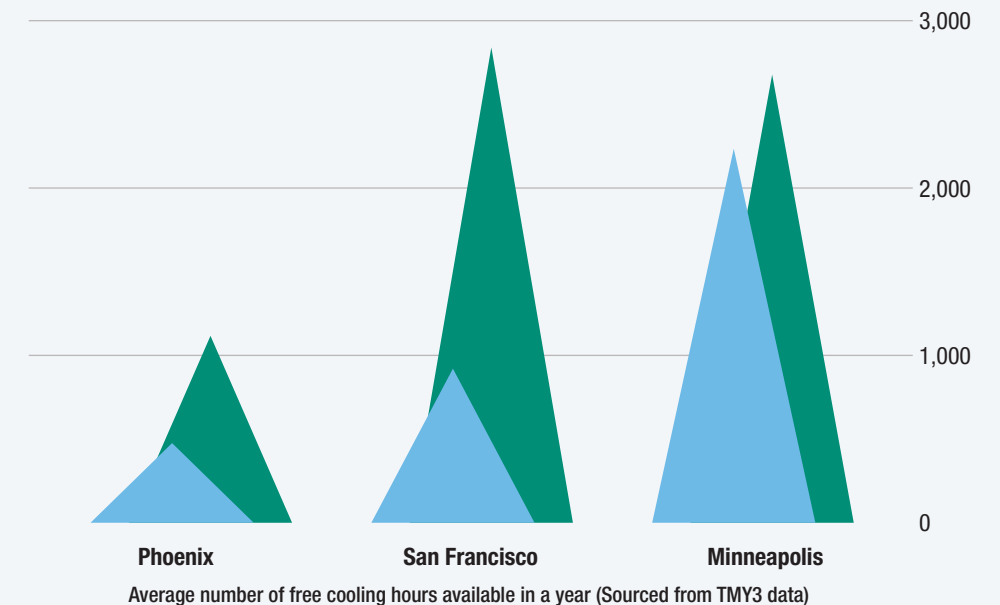

## Lower Noise Levels

Lowering background noise levels can help reduce the impact on concentration levels of both teachers and students. In 2012, ANSI introduced a new standard for classroom noise levels, S12.60. This standard states that background noise levels in all core learning areas should not exceed 35 dBA (N27).

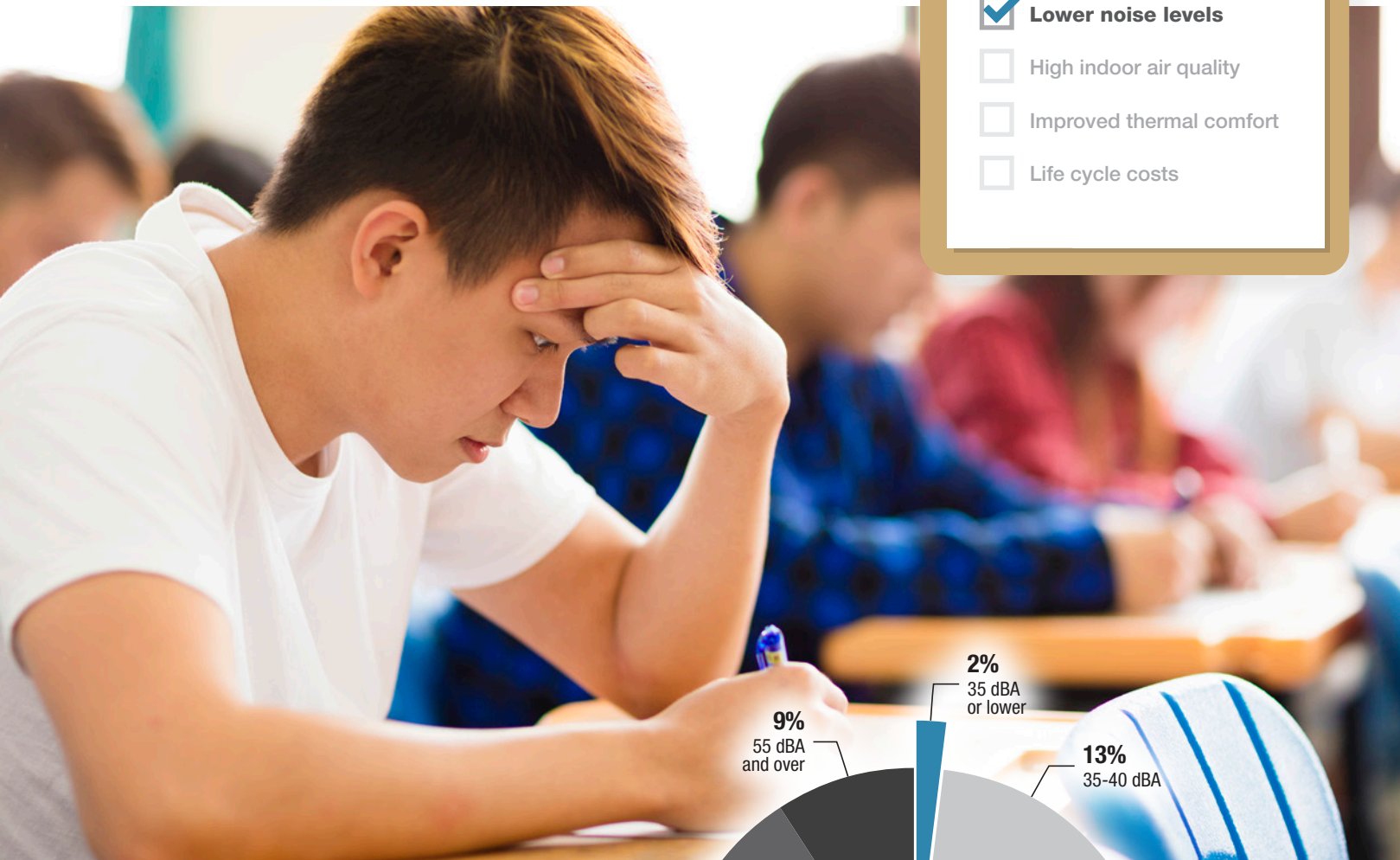

**CONSIDERATIONS**

- Low maintenance
- Low operating costs
- Lower noise levels**
- High indoor air quality
- Improved thermal comfort
- Life cycle costs

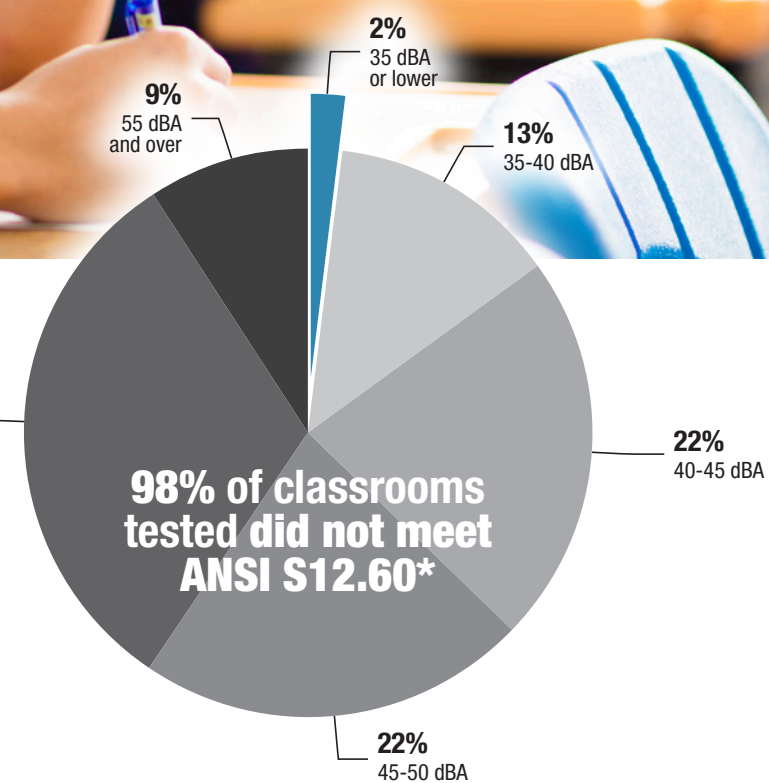

Experience has shown that in practice these sound level targets are not being met. The results from a recent study found that only 1 out of 54 classrooms met the <35dBA target.<sup>10</sup> A major contributor as to why classrooms failed to meet the standard were the installed HVAC systems.

## Traditional HVAC Systems vs Displacement Systems

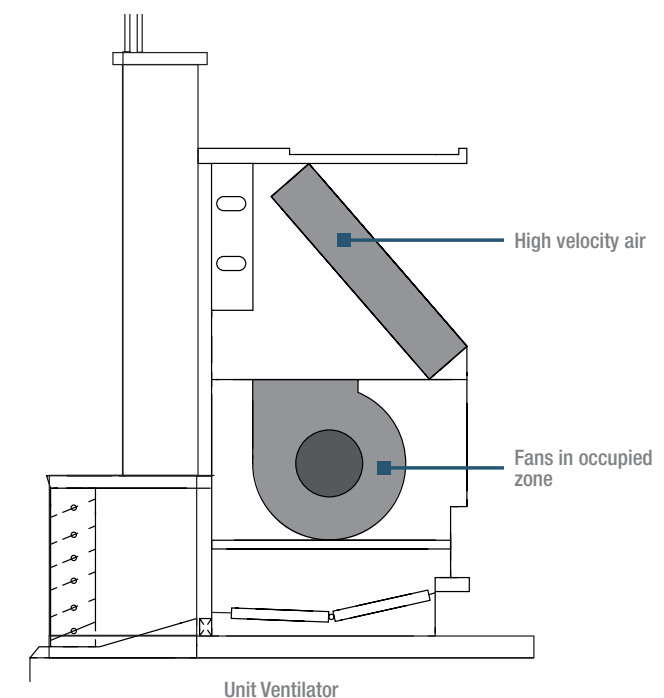

Traditional HVAC systems with built-in fans, and units required to move large amounts of air contribute to poor acoustics.

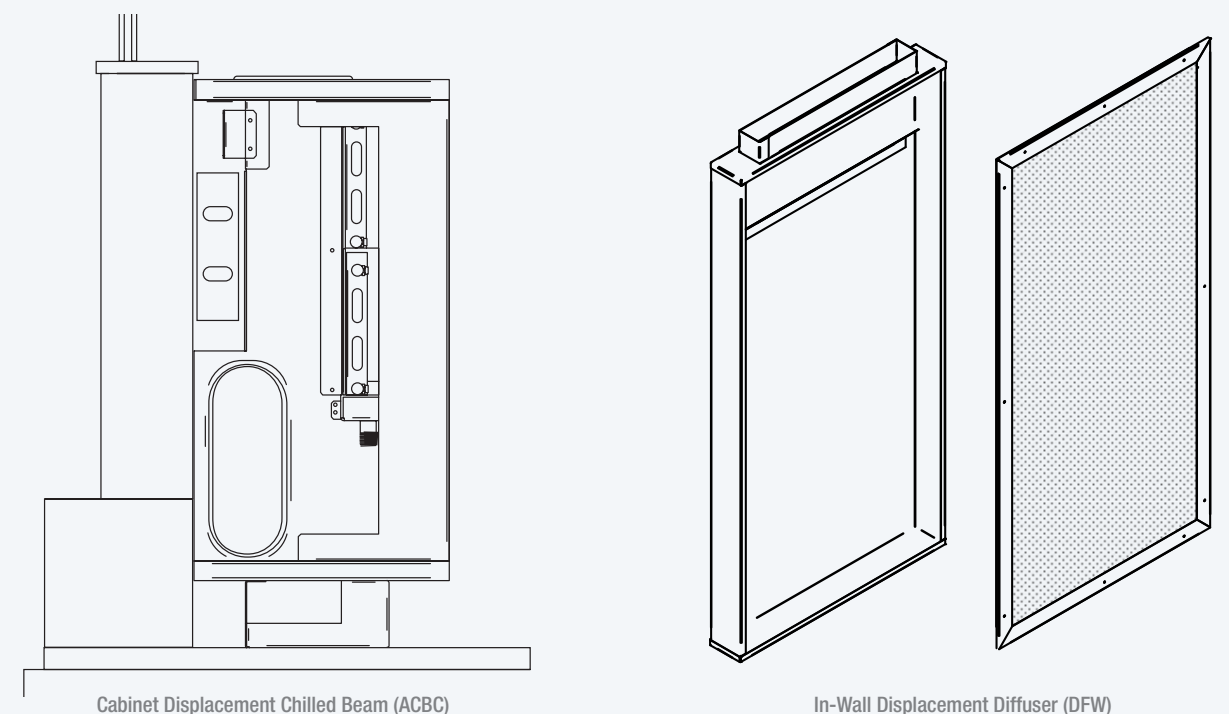

Displacement and chilled beam systems have no moving parts or built-in fans, and they release air slowly making them inherently very quiet.

# High Indoor Air Quality

Indoor environmental quality (IAQ) has been proven by several independent studies to have a major impact on health, performance and attendance of students and teachers. Displacement ventilation has shown significant improvements of the air quality in classrooms on a number of studies conducted.<sup>11,12,13,14</sup>

The image below shows provides an illustration of what happens when contaminants, such a child sneezing, enters the space. In a mixing space the particles released in a sneeze would be mixed throughout the space. In a displacement system the particles are pushed upward, and out of the breathing zone.

**CONSIDERATIONS**

- Low maintenance
- Low operating costs
- Lower noise levels
- High indoor air quality**
- Improved thermal comfort
- Life cycle costs

Displacement ventilation systems have led to higher overall school indoor air quality and **lower CO<sub>2</sub> levels**. Many schools report **reduced absenteeism**, some as high as 25%.

*Massachusetts Design Engineer Principal*

In a mixing system the sneeze particles (red) are mixed throughout the space.

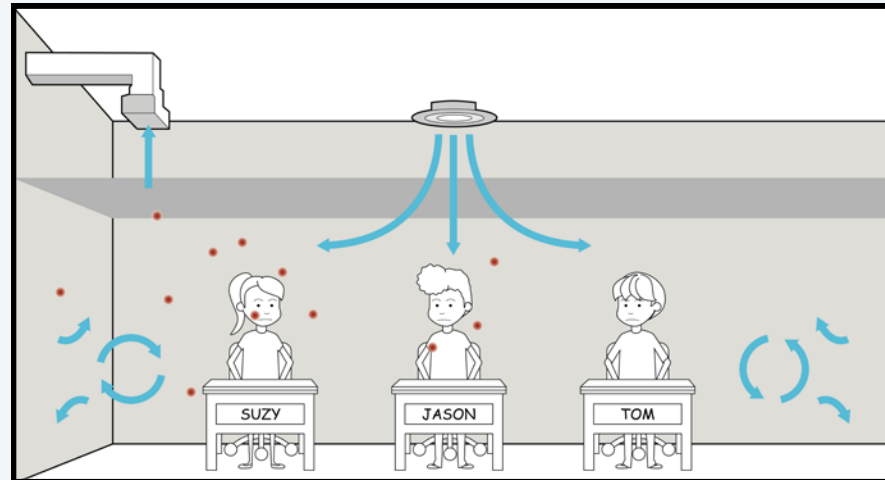

In a displacement system the sneeze particles (red) are pushed up and out of the breathing zone.

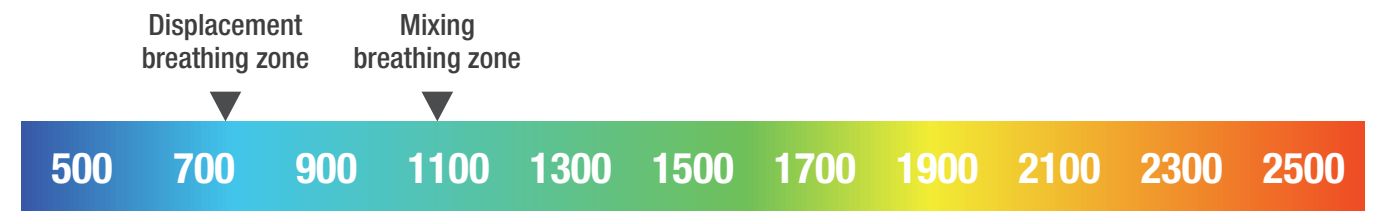
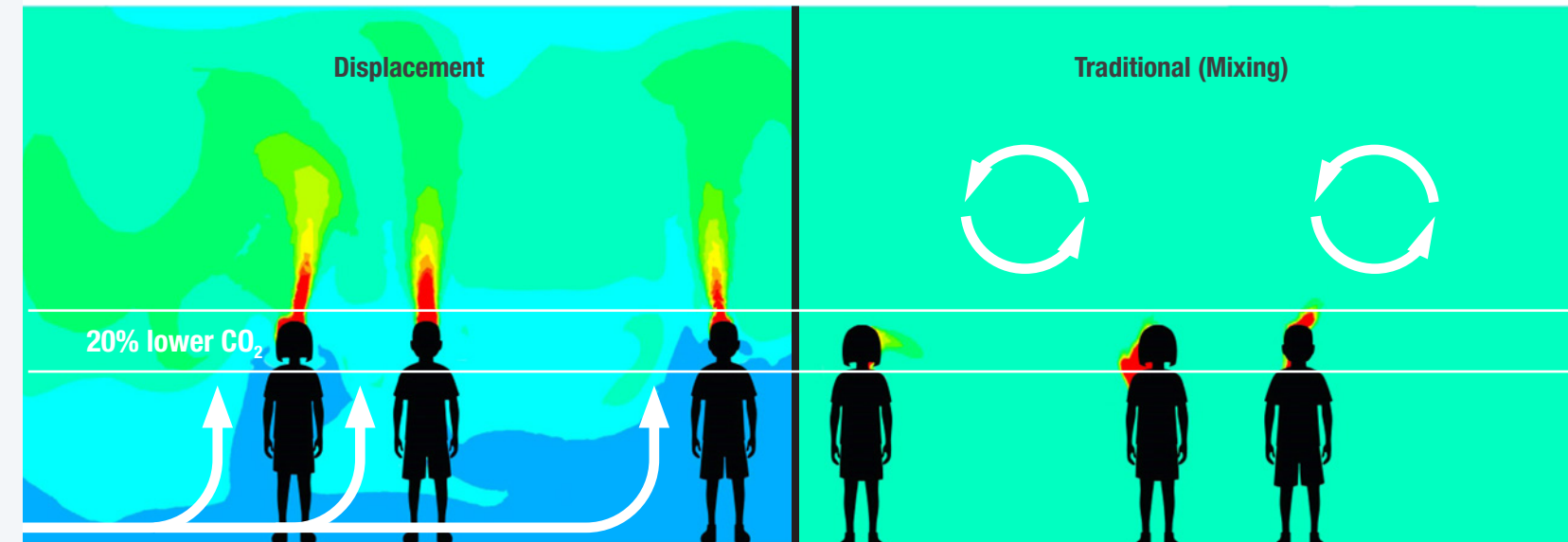
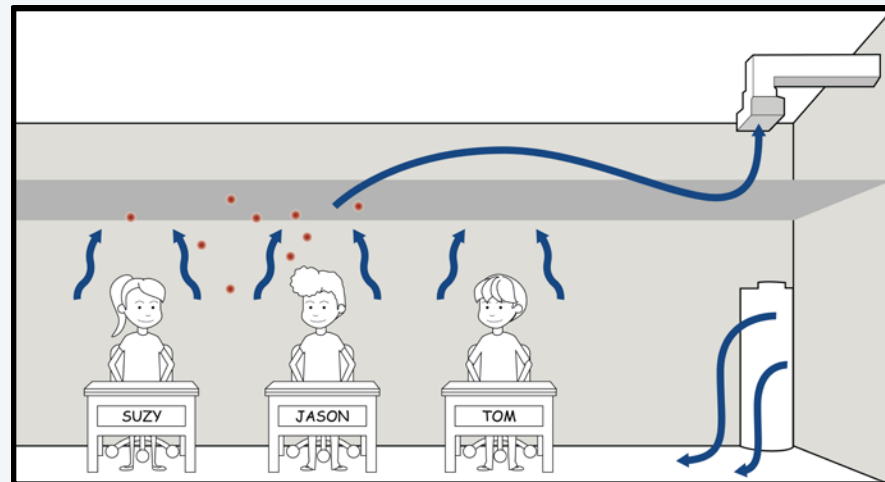

A number of studies have proven that high CO<sub>2</sub> in the breathing zone can lead to a decrease in test performance and an increase in poor health related symptoms such as asthma.<sup>15,16,17,18</sup>

## Improved Thermal Comfort

Displacement Ventilation supplies at low velocity with warmer air and is driven naturally by the heat sources and occupants throughout the space providing superior comfort.

We've used displacement for a couple of reasons, the main one being introducing air at the ground level and making it a lot more comfortable for occupants in the building.

- Director of Architecture and Design Services, Davis Schools District

**CONSIDERATIONS**

- Low maintenance
- Low operating costs
- Lower noise levels
- High indoor air quality
- Improved thermal comfort**
- Life cycle costs

## Some traditional systems can lead to uncomfortable thermal conditions

If a unit ventilator is being considered for a classroom it is important to note that these products can experience infiltration issues over time. The leakage can be very difficult and costly for schools to fix, and it can cause significant comfort and air quality issues in the classroom.

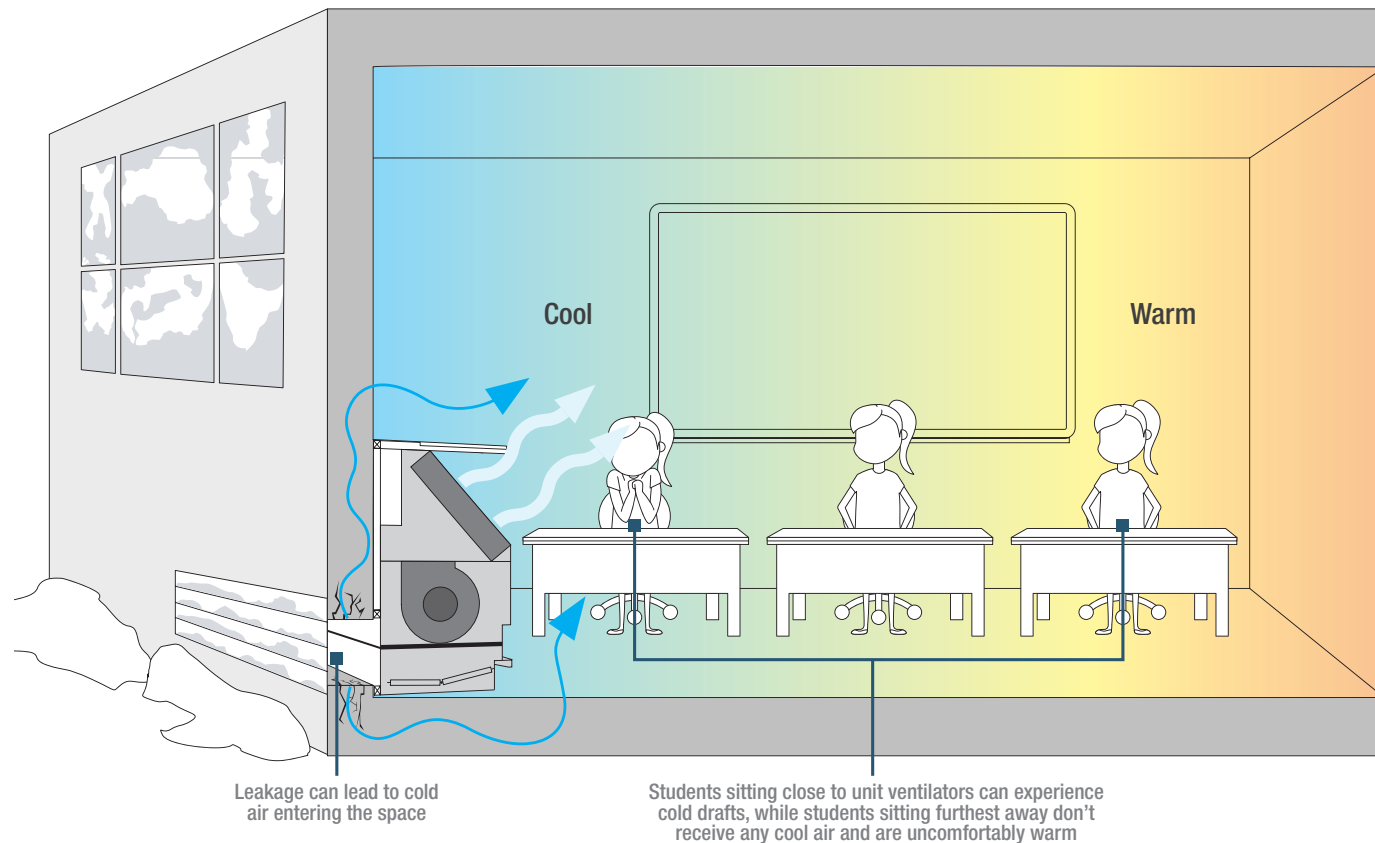

## Life Cycle Costs

The versatility of a chilled beam and displacement systems allows you to design for every budget. Initial costs can be controlled through the proper selection of components, the implementation of technology, a well engineered control strategy, and a competitive bid process. Various climatic regions have adopted displacement ventilation as the standard in classroom design and noted that these systems have a comparable first cost to other commonly used HVAC systems.



**CONSIDERATIONS**

- Low maintenance
- Low operating costs
- Lower noise levels
- High indoor air quality
- Improved thermal comfort
- Life cycle costs**

Displacement ventilation can lead to improved student performance and attendance which is directly related to government funding levels in many states. Many states receive around \$8,000 for yearly funding per average daily attendance. For example, **California received \$7,300 - \$8,940 per average daily attendance depending on grade level in 2017-2018.**<sup>19</sup>

Typically we would expect that displacement ventilation HVAC systems are 20-30% more efficient than code base line systems; and the pay back periods are nearly instantaneous.

*Massachusetts Design Engineer Principal*





Classroom Layout: All Air Displacement

## All Air Displacement

### Low Wall Displacement

The diffuser and plenum are designed to fit within a wall opening. The diffuser is also fashioned with a flanged border to cover the hole opening in the wall.

- Superior air quality
- Zero in-space maintenance
- Increased economizer hours
- Improved acoustics
- No central chiller plant required

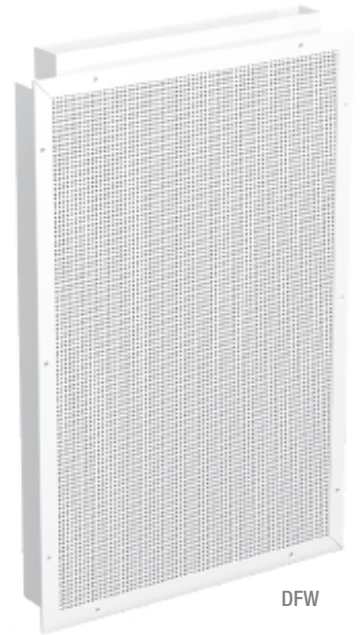

### Product Alternative: Diffuser Integrated into Furniture

In this example the diffuser is installed within the vertical kicker underneath the cabinet and bookshelves. This allows the air to be supplied inconspicuously and without taking up additional floor space.

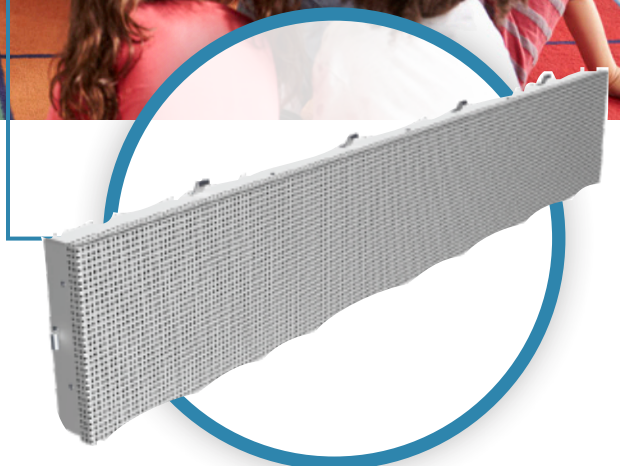



Classroom Layout: Chilled Beam Displacement

## Chilled Beam Displacement

### Floor Mounted Displacement Chilled Beam (ACBC)

- Take advantage of a central chilled / hot water system
- Reduce airflow and ductwork sizing and cost ( $\leq$  half)
- Combines the efficiencies of hydronic and displacement systems
- Energy efficient system with the ability to provide Demand Control Ventilation
- Optional convective heating can provide easy morning warm-up without the need of a central AHU
- Low level air supply creates a stratified room condition
- Available with additional accessories, including: bookshelves, utility cabinet, filler section, etc.

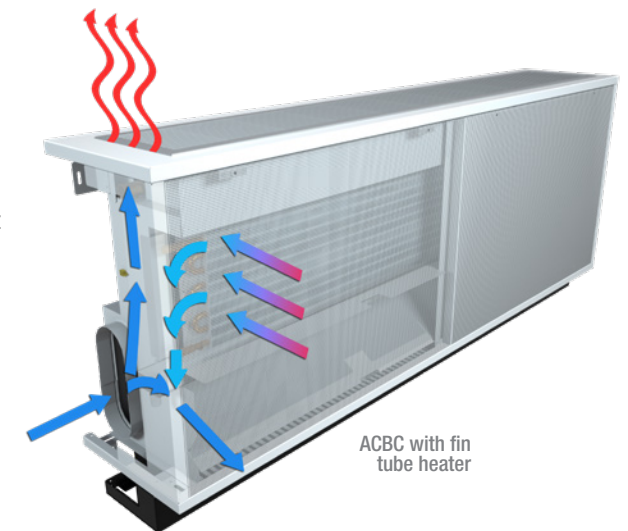

### Product Alternative: Administrative Office and Hallway Area



In other areas such as administrative offices and hallways consider using ACBLs for overhead mixing



Classroom Layout: Overhead Mixing with Chilled Beams

## Overhead Mixing with Chilled Beams

### Active Linear Chilled Beam (ACBL)

The ACBL is designed provide a high cooling and heating output while simultaneously supplying fresh air to the occupied area. A mix of fresh air and conditioned room air is distributed to the room through one or two slots integrated into the beam.

- Ideal solution for situations where floor space is a premium
- Reduce airflow and ductwork sizing and cost ( $\leq$  half)
- Energy efficient system with the ability to provide Demand Control Ventilation



# Retrofit Applications

## Classrooms with Existing Cabinet Unit Ventilators or Fan Coils

ACBC units are an excellent option for schools looking to upgrade their system from unit ventilators or fan coils. All that is required is the removal of the old units, placement of the ACBCs, and reconnection of the existing water coils.

### BENEFITS

- Least invasive system with low first cost impact
- Improved comfort
- Improved acoustics
- Reduced maintenance expense
- Improved IAQ

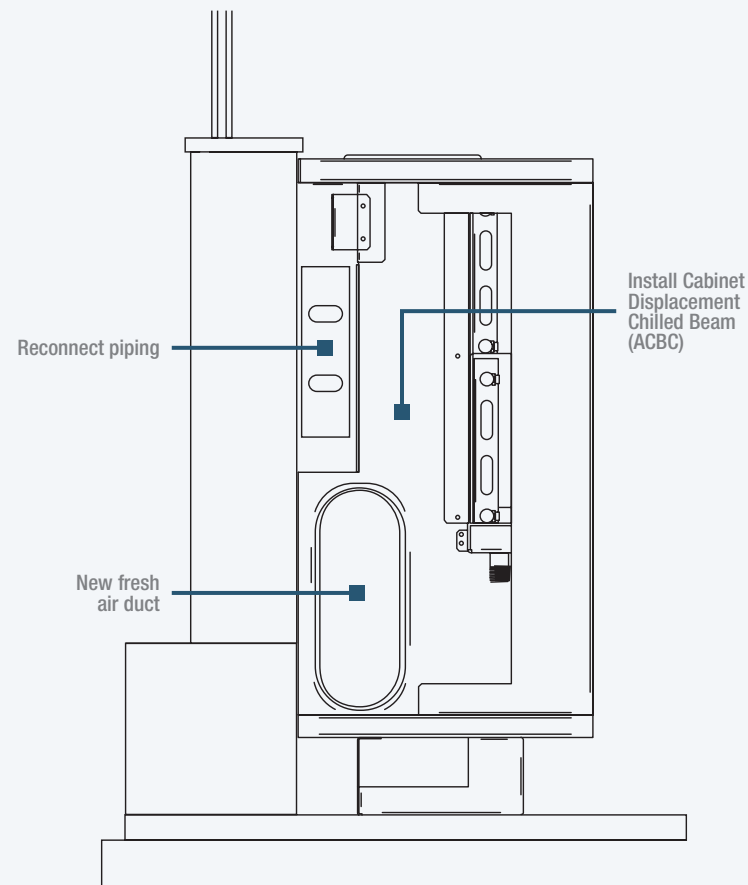
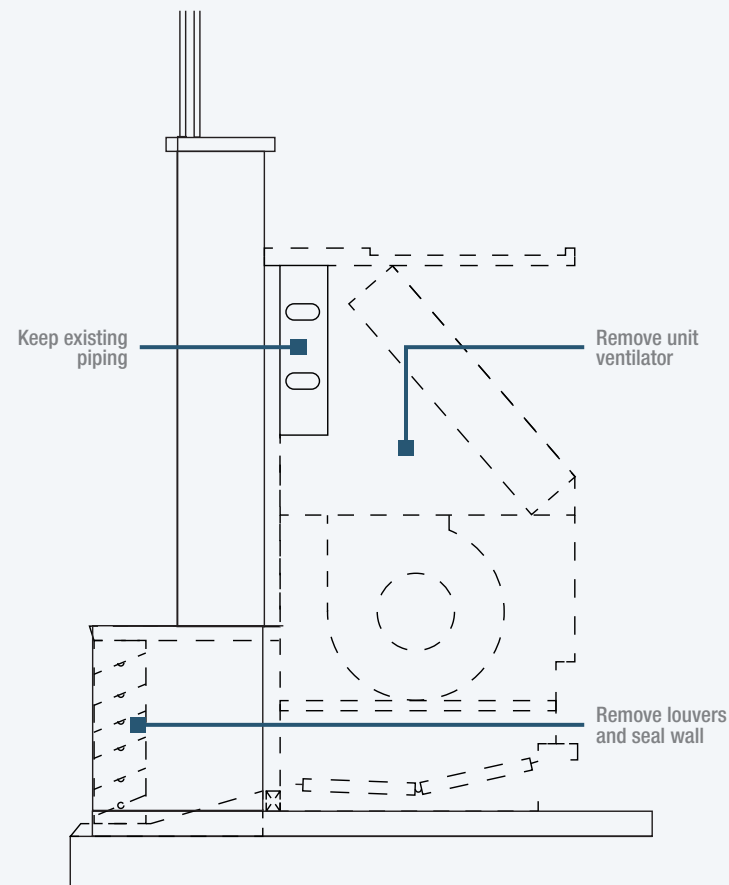

## Schools with In-Closet Unit Ventilators

A chilled beam system can easily be installed into a building with existing closet unit ventilators and chilled water piping. To install the chilled beams you will need to add duct work and reconnect the chilled water piping.

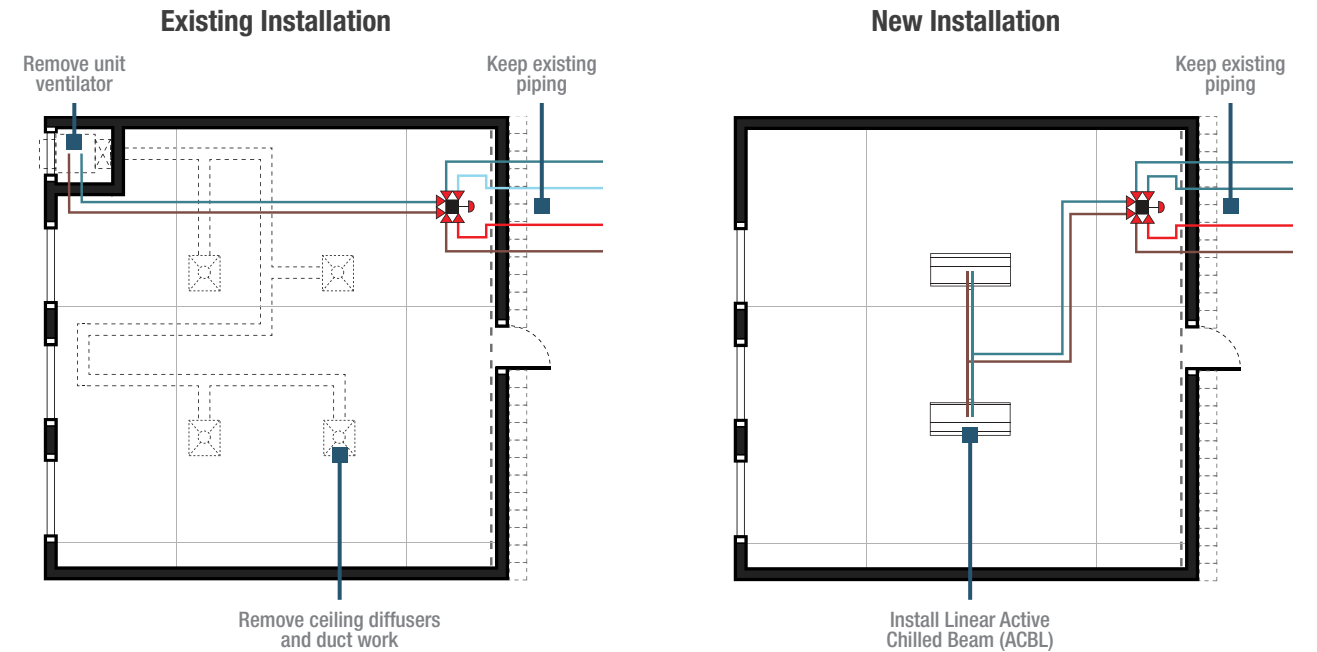

## Schools with Ventilation and Heating Only

Schools that use ventilation and heating only can be retrofitted with a chilled beam system by removing the heating coil and ceiling diffusers, adding in the chilled beams, reconnecting the hot water piping and adding in a chilled water supply.

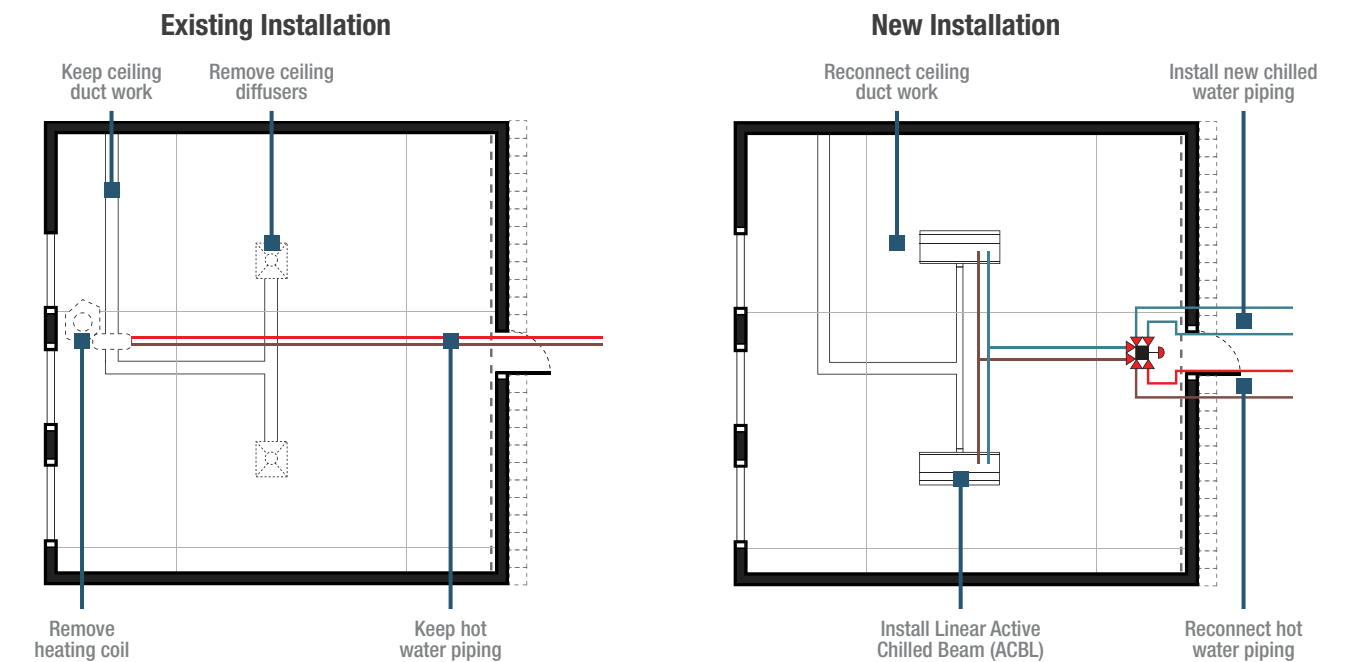

# Endnotes

- 1, 2 United States Environmental Protection Agency. (2018, December 21). Designing and Constructing High Performance Schools for a Healthy School Environment. Retrieved from United States Environmental Protection Agency: <https://www.epa.gov/schools-healthy-buildings/designing-and-constructing-high-performance-schools-healthy-school>
- 3 International Well Building Institute. (n.d.). Retrieved from International Well Building Institute: <https://www.wellcertified.com/en>
- 4 Collaborative for High Performance Schools. (n.d.). Retrieved from Collaborative for High Performance Schools: <https://chps.net/>
- 5 U.S. Green Building Council. (n.d.). Retrieved from U.S. Green Building Council: <https://new.usgbc.org/>
- 6 Camera, L. (2018, January 31). *Will Trump Help Rebuild America's Schools?* Retrieved from U.S. News: <https://www.usnews.com/news/the-report/articles/2018-01-31/infrastructure-spending-for-schools-if-history-repeats-itself-no>
- 7 United States Environmental Protection Agency. (2019, March 11). *Creating Healthy Indoor Air Quality in Schools*. Retrieved from United States Environmental Protection Agency: <https://www.epa.gov/iaq-schools>
- 8 Trane. (2017, February). *Installation, Operation, and Maintenance*. Retrieved from Trane: [https://www.trane.com/content/dam/Trane/Commercial/global/products-systems/equipment/ductless/variable-refrigerant-volume/VRF-SVX26D-EN\\_02012017.pdf](https://www.trane.com/content/dam/Trane/Commercial/global/products-systems/equipment/ductless/variable-refrigerant-volume/VRF-SVX26D-EN_02012017.pdf)
- 9, 11 ASHRAE. (2013). *ANSI/ASHRAE Standard 62.1-2013: Ventilation for Acceptable Indoor Air Quality*. ASHRAE.
- 10 ATS&R, Kvernstoen, Ronnholm & Associates Inc. (2007). *Classroom Acoustical Study*. Air Conditioning and Refrigeration Institute (ARI).
- 12 Arent, J., Eley, C., & Meister, B. (2006). Displacement Ventilation in Action: Performance Monitoring of Demonstration Classrooms. ACEE Summer Study on Energy Efficiency in Buildings.
- 13 Smedje, G., & Norback, D. (2000). New Ventilation Systems at Select Schools in Sweden - Effects on Asthma and Exposure.
- 14 Jung, A., and M. Zeller, 2005. Analysis and Testing of Methods to Determine Indoor Air Quality and Air Change Effectiveness. Original technical paper from Rheinisch-Westfälische Technical University of Aachen, Germany, 1994.
- 15 Allen, J. G., & al., e. (2015). Associations of Cognitive Function Scores with CO<sub>2</sub>, Ventilation and VOC Exposures in Office Workers; A Controlled Exposure Study of Green and Conventional Office Environments. *Environmental Health Perspectives* 124.6.
- 16 Shendell, D., Prill, R., Fisk, W., Apte, M., Blake, D., & Faulkner, D. (2004). Associations Between Classroom CO<sub>2</sub> Concentrations and Student Attendance in Washington and Idaho. *Indoor Air*.
- 17 Loftness, V., Hartkopf, V., & Khee Poh, L. (2006). Sustainability and Health are Integral Goals for the Built Environment. *Healthy Buildings*. Lisbon: Healthy Buildings.
- 18 Kim, C. S., Lim, Y. W., Yang, J. Y., Hong, C. S., and Shin, D. C., (2002) Effect of Indoor CO<sub>2</sub> concentrations on Wheezing Attacks in Children. *Indoor Air '02: Proceedings of the 9th International Conference on Indoor Air Quality and Climate*.
- 19 California Department of Education. (2019, February 20). *Funding Rates and Information, Fiscal year 2017-18*. Retrieved from California Department of Education: <https://www.cde.ca.gov/fg/aa/pa/pa1718rates.asp#absencerate>



Watch our Displacement in Schools case study video



Contact us today at [schools@priceindustries.com](mailto:schools@priceindustries.com)

Product Improvement is a continuing endeavour at Price. Therefore, specifications are subject to change without notice. Consult your Price Sales Representative for current specifications or more detailed information. Not all products may be available in all geographic areas. All goods described in this document are warranted as described in the Limited Warranty shown at [priceindustries.com](http://priceindustries.com). The complete Price product catalog can be viewed online at [priceindustries.com](http://priceindustries.com).